

FEATURES

- VOLTAGE: 50 TO 1000 VOLTS, CURRENT; 1.0 AMPERE
- CORRESPONDS TO 1N4001 THRU 1N4007 IN SURFACE MOUNT PACKAGE
- FLAT PACK - LOW PROFILE, FOR SURFACE MOUNT APPLICATIONS
- GLASS PASSIVATED CHIP CONSTRUCTION
- MEETS FLAMMABILITY REQUIREMENTS OF UL94V-0
- HIGH TEMPERATURE SOLDERING (250°C/10 SECONDS)
- EASY PICK AND PLACE

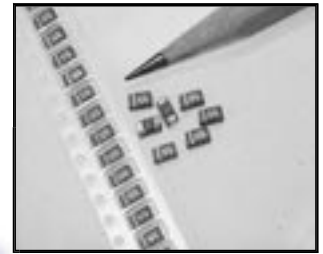

**RoHS
Compliant**

includes all homogeneous materials

*See Part Number System for Details

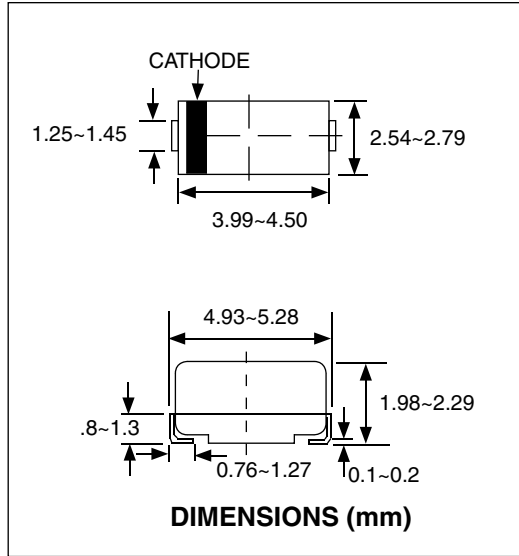

MECHANICAL DATA:

SIZE: SMA/DO-214AC

CASE: Molded epoxy

TERMINALS: Solder plated Copper alloy

POLARITY: Indicated by cathode band

STANDARD PACKAGING: 12mm tape (EIA-RS-481)

WEIGHT: 0.064 gram

PART NUMBERING SYSTEM

NRD 4004 TR -5K E

- NRD: Series
- 4004: Voltage designator (See table below)
- TR: Tape and Reel
- 5K: Reel qty: (5K & 7.5K)
- E: RoHS Compliant

MAXIMUM RATINGS (At $T_A=25^\circ\text{C}$ unless otherwise noted)

Ratings	Symbol	NRD4001	NRD4002	NRD4003	NRD4004	NRD4005	NRD4007	UNITS
Maximum Recurrent Peak Reverse voltage	VRRM	50	100	200	400	600	1000	Volts
Maximum RMS voltage	VRMS	35	70	140	280	420	700	Volts
Maximum DC Blocking Voltage	VDC	50	100	200	400	600	1000	Volts
Maximum Average Forward Rectified Current $T_A=75^\circ\text{C}$	I_o	1.0						Amps
Peak Forward Surge Current 8.3ms single half sine-wave superimposed on rated load (JEDEC method)	IFSM	30						Amps

ELECTRICAL CHARACTERISTICS (At $T_A=25^\circ\text{C}$ unless otherwise noted)

Characteristics	Symbol	NRD4001	NRD4002	NRD4003	NRD4004	NRD4005	NRD4007	UNITS
Maximum Forward Voltage at 1.0A DC	VF	1.1						Volts
Maximum Full Load Reverse Current Full Cycle Average @ $T_A=75^\circ\text{C}$	IR	30						μAmps
Maximum DC Reverse Current at Rated DC Blocking Voltage @ $T_A=25^\circ\text{C}$		5.0						μAmps
Maximum DC Reverse Current at Rated DC Blocking Voltage @ $T_A=125^\circ\text{C}$		50						μAmps
Maximum Thermal Resistance (Note 1)	R_{qJL}	30						$^\circ\text{C/W}$
Typical Junction Capacitance (Note 2)	CJ	15						pF
Operating and Storage Temperature Range	TJ, TSTG	-60 ~ +150 $^\circ\text{C}$						$^\circ\text{C}$
Maximum Reverse Recovery Time (Note 3)	t_{rr}	2.5						μS

NOTES:

1. Thermal resistance junction to terminal, 5mm^2 (0.013 mm Thick) copper land patterns.
2. Measured at 1.0 MHz and applied average voltage of 4.0VDC.
3. Reverse recovery test conditions: $I_f=0.5\text{A}$, $I_R=1.0\text{A}$, $t_{rr}=0.25\text{A}$

RATINGS AND CHARACTERISTICS CURVES (NRD4001 THRU 4007)

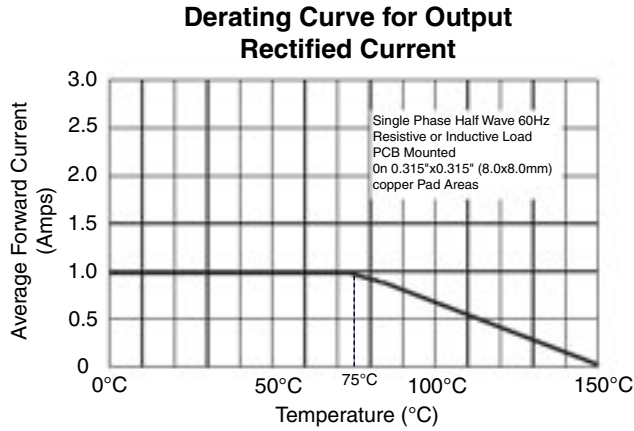

Typical Instantaneous Forward Characteristics per Element

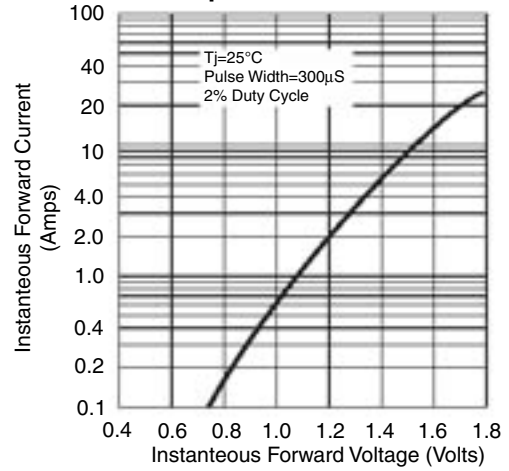

Typical Peak Reverse Characteristics

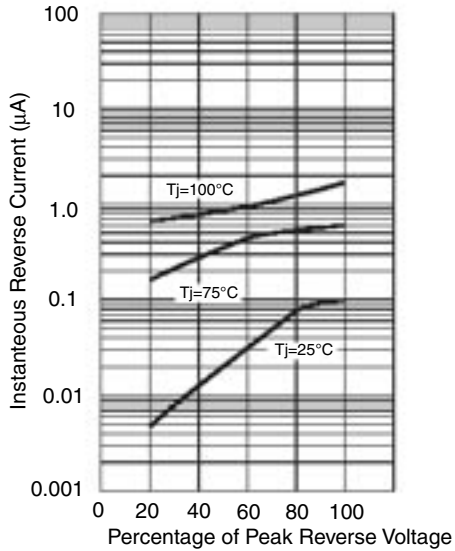

Maximum Non-repetitive Peak Forward Surge Current

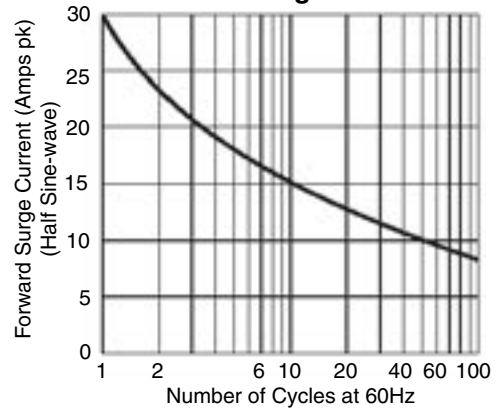

Transient Thermal Impedance

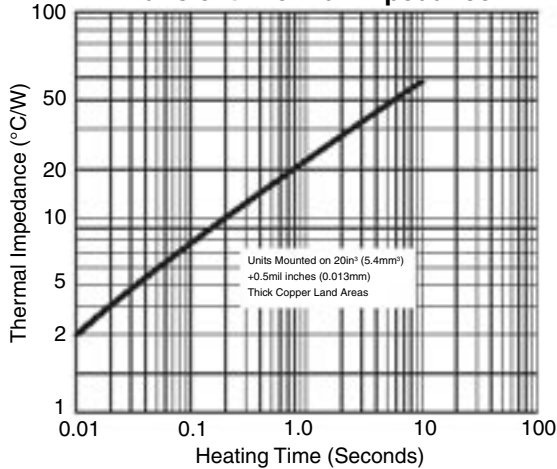

Typical Junction Capacitance per Element

