

FEATURES

- SHIELDED POWER INDUCTOR
- MOLDED METAL COMPOSITE CONSTRUCTION
- HIGH SATURATION CURRENT CHARACTERISTICS (~ 110A)
- HIGH EFFICIENCY (2X IMPROVEMENT OVER FERRITE CORE INDUCTORS)
- LOW PROFILE (1.8mm ~ 5.2mm)

RoHS Compliant
includes all homogeneous materials

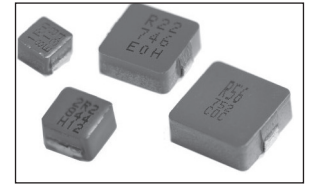

*See Part Number System for Details

CHARACTERISTICS

Case Code	42C	74C	104C	143C	145C
Inductance Range (μH)	0.1 ~ 1.0	0.1 ~ 6.8	0.68 ~ 2.2	0.22 ~ 3.3	0.36 ~ 6.8
Ambient Operating Temperature Range	-55°C ~ +85°C				
Maximum Component Temperature (Ambient + Self-Heating)	+125°C				
Temperature Rise at Irms	+40°C				
Inductance Change at Isat	-20%				
Inductance Tolerance	±20%				
Resistance to Solder Heat	260°C ±5°C for 10 seconds				

DIMENSIONS (mm)

Series	Value	A	B	C	D ₁	D ₂	E ₁	E ₂	t
NPIM42C	All	4.15 ± 0.35	4.0 ± 0.3	1.8 ± 0.2	0.8 ± 0.3	1.0 ± 0.1	1.5 ± 0.3	2.2 ± 0.2	0 ~ +0.15
NPIM74C	All	6.95 ± 0.35	6.6 ± 0.2	2.8 ± 0.2	1.6 ± 0.3	2.0 ± 0.1	3.0 ± 0.3	3.6 ± 0.2	0 ~ +0.15
NPIM104C	R15 ~ 1R5	11.15 ± 0.35	10.0 ± 0.3	3.8 ± 0.2	2.0 ± 0.5	2.5 ± 0.1	3.0 ± 0.5	5.0 ± 0.2	0 ~ +0.15
	2R2 ~ 4R7	10.85 ± 0.35							
NPIM143C	R22 ~ R68	13.45 ± 0.35	12.6 ± 0.2	3.3 ± 0.2	2.0 ± 0.5	2.5 ± 0.1	4.0 ± 0.5	6.0 ± 0.2	0 ~ +0.15
	1R0 ~ 3R3	13.45 ± 0.35					3.0 ± 0.5		
NPIM145C	R36	13.65 ± 0.35	12.6 ± 0.2	5.0 ± 0.2	2.0 ± 0.5	2.5 ± 0.1	4.0 ± 0.5	6.0 ± 0.2	0 ~ +0.15
	R15 ~ 1R5	13.45 ± 0.35		4.8 ± 0.2			3.0 ± 0.5		
	2R2 ~ 6R8								



PART NUMBER SYSTEM

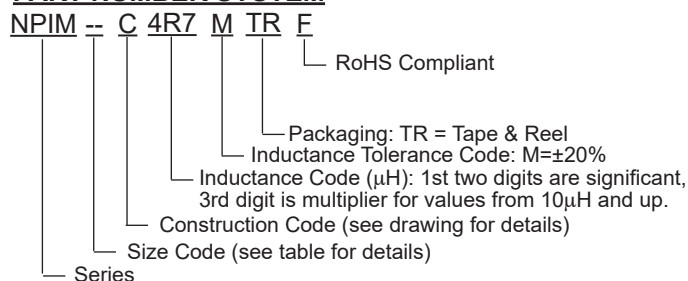

Part Number	STANDARD VALUES - CASE SIZE 42C (4.15 X 4.0 X 1.8mm)				Test Frequency
	Inductance Value (μH)	DC Resistance (mΩ)	DC Current Irms (Amps)	DC Current Isat (Amps)	
NPIM42CR10MTRF	0.1	5.0	11	30	100KHz
NPIM42CR22MTRF	0.22	8.0	9	17	
NPIM42CR47MTRF	0.47	15.5	6	11.5	
NPIM42C1R0MTRF	1.0	36	3.8	8.5	

Maximum +40°C temperature rise at Irms. Typical -20% inductance change at Isat.

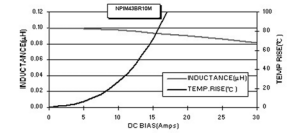

Contact NIC for NPIM42C Performance Curves

Part Number	STANDARD VALUES - CASE SIZE 74 (6.95 X 6.6 X 2.8mm)				Test Frequency
	Inductance Value (μH)	DC Resistance (mΩ)	DC Current Irms (Amps)	DC Current Isat (Amps)	
NPIM74CR10MTRF	0.1	1.7	32.5	60	100KHz
NPIM74CR20MTRF	0.2	3	24	41	
NPIM74CR22MTRF	0.22	2.8	23	40	
NPIM74CR33MTRF	0.33	3.9	20	30	
NPIM74CR47MTRF	0.47	4.2	17.5	26	
NPIM74CR56MTRF	0.56	5	16.5	25.5	
NPIM74CR68MTRF	0.68	5.5	15.5	25	
NPIM74CR75MTRF	0.75	6.2	14	24.5	
NPIM74CR82MTRF	0.82	8	13	24	
NPIM74C1R0MTRF	1.0	10	11	22	
NPIM74C1R2MTRF	1.2	12	10	20	
NPIM74C1R5MTRF	1.5	15	9	18	
NPIM74C2R0MTRF	2.0	18	8.2	14	
NPIM74C2R2MTRF	2.2	20	8	14	
NPIM74C2R5MTRF	2.5	22	7	14	
NPIM74C3R3MTRF	3.3	30	6	13.5	
NPIM74C4R7MTRF	4.7	40	5.5	10	
NPIM74C6R8MTRF	6.8	60	4.5	8	

Maximum +40°C temperature rise at Irms. Typical -20% inductance change at Isat

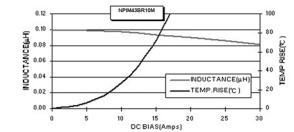

Contact NIC for NPIM74C Performance Curves

Part Number	STANDARD VALUES - CASE SIZE 104C				Test Frequency
	Inductance Value (μH)	DC Resistance (mΩ)	DC Current Irms (Amps)	DC Current Isat (Amps)	
NPIM104CR68MTRF	0.68	2.7	22	39	100KHz
NPIM104CR88MTRF	0.88	3.0	20	38	
NPIM104C1R5MTRF	1.5	4.2	16	33	
NPIM104C2R2MTRF	2.2	7.0	12	27	

Maximum +40°C temperature rise at Irms. Typical -20% inductance change at Isat.

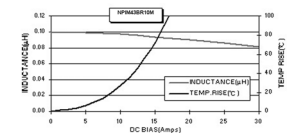

Contact NIC for NPIM104C Performance Curves

Part Number	STANDARD VALUES - CASE SIZE 143C				Test Frequency
	Inductance Value (μH)	DC Resistance (mΩ)	DC Current I _{rms} (Amps)	DC Current I _{sat} (Amps)	
NPIM143CR22MTRF	0.22	1.3	38	65	100KHz
NPIM143CR33MTRF	0.33	1.5	36.5	62	
NPIM143CR47MTRF	0.47	2.0	32	55	
NPIM143CR56MTRF	0.56	2.2	29	51	
NPIM143CR62MTRF	0.62	2.2	29	51	
NPIM143CR68MTRF	0.68	2.5	28	49	
NPIM143CR82MTRF	0.82	3.0	25	44	
NPIM143C1R0MTRF	1.0	3.5	24	40	
NPIM143C2R2MTRF	2.2	8.0	16	29	
NPIM143C3R3MTRF	3.3	12	12	27	

Maximum +40°C temperature rise at I_{rms}. Typical -20% inductance change at I_{sat}.

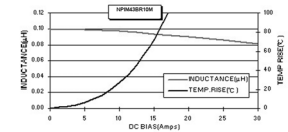

Contact NIC for NPIM143C Performance Curves

Part Number	STANDARD VALUES - CASE SIZE 145C				Test Frequency
	Inductance Value (μH)	DC Resistance max. (mΩ)	DC Current I _{rms} (Amps)	DC Current I _{sat} (Amps)	
NPIM145CR36MTRF	0.36	1.1	41	75	100KHz
NPIM145CR47MTRF	0.47	1.3	38	65	
NPIM145CR50MTRF	0.5	1.5	36	55	
NPIM145CR56MTRF	0.56	1.5	36	55	
NPIM145CR62MTRF	0.62	1.7	34	54	
NPIM145CR68MTRF	0.68	1.7	34	54	
NPIM145CR82MTRF	0.82	2.1	31	53	
NPIM145C1R0MTRF	1.0	2.5	29	50	
NPIM145C1R5MTRF	1.5	4.1	23	48	
NPIM145C2R2MTRF	2.2	5.5	20	32	
NPIM145C3R3MTRF	3.3	9.2	15	32	
NPIM145C4R7MTRF	4.7	15	12	27	
NPIM145C6R8MTRF	6.8	18.5	11	21	

Maximum +40°C temperature rise at I_{rms}. Typical -20% inductance change at I_{sat}.

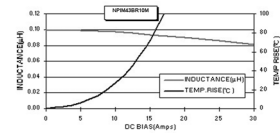

Contact NIC for NPIM145C Performance Curves

CARRIER TAPE DIMENSIONS (mm)

Series	Part Thickness	Ao	Bo	Co	Po	Ko	t	W
NPIM42C	All	4.2 ± 0.10	4.5 ± 0.10	5.5 ± 0.10	8.0 ± 0.10	2.5 ± 0.15	1.55 ± 0.05	12.0 ± 0.30
NPIM74C	All	7.2 ± 0.10	7.5 ± 0.10	7.5 ± 0.10	12.0 ± 0.10	3.6 ± 0.15	0.30 ± 0.10	16.0 ± 0.30
NPIM104C	All	10.7 ± 0.10	12.0 ± 0.10	11.5 ± 0.10	16.0 ± 0.10	4.0 ± 0.10	0.35 ± 0.05	24.0 ± 0.30
NPIM143C	All	13.4 ± 0.10	14.1 ± 0.10	11.5 ± 0.10	16.0 ± 0.1	3.7 ± 0.15	0.35 ± 0.05	24.0 ± 0.30
NPIM145C	All	13.4 ± 0.10	14.1 ± 0.10	11.5 ± 0.10	16.0 ± 0.1	5.1 ± 0.10	0.35 ± 0.05	24.0 ± 0.30

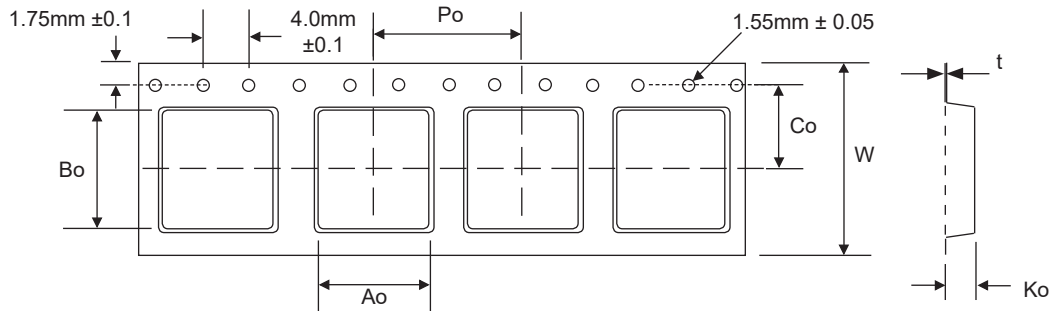

REEL DIMENSIONS (mm)

Series	A	B	Qty/Reel
NPIM42C	12.5 ± 0.5	2.0 ± 0.2	2,000
NPIM74C	16.0 ± 0.5	2.0 ± 0.2	1,000
NPIM104C	24.5 ± 0.5	2.0 ± 0.2	500
NPIM143C	24.5 ± 0.5	2.0 ± 0.2	500
NPIM145C	24.5 ± 0.5	2.0 ± 0.2	500

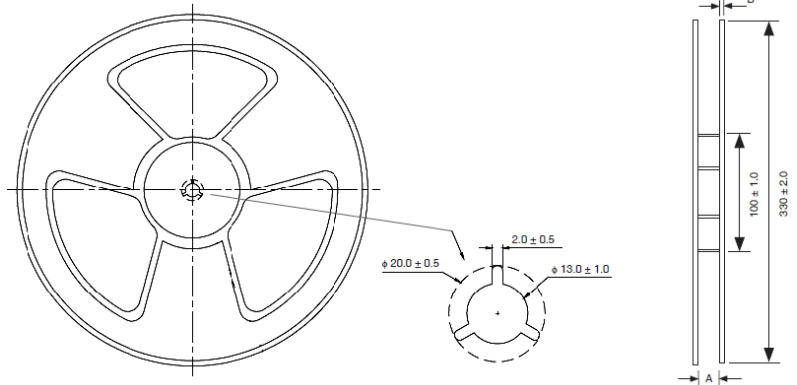

Land Patterns (mm)

Series	F	G	H
NPIM42C	2.2	5.2	2.5
NPIM74C	3.7	8.4	3.5
NPIM104C	5.4	13.6	4.1
NPIM143C	8.0	14.5	5.0
NPIM145C	8.0	14.5	5.0

