

Current Sensing Chip Resistors

NCSR Series

FEATURES

- SURFACE MOUNTABLE 2512 CASE SIZE
- LOW RESISTANCE & LOW INDUCTANCE METAL STRIP CONSTRUCTION
- PRECISION TOLERANCE ($\pm 1\%$) AND TCR (± 50 PPM) TO $+170^\circ\text{C}$
- TAPED & REEL PACKAGING FOR EASY PICK AND PLACE
- REFLOW COMPATIBLE

RoHS Compliant
includes all homogeneous materials

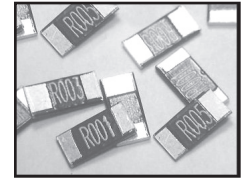

See Part Number System for Details

SPECIFICATIONS

Type	EIA Size	Power Rating at 80°C	Case Type**	Resistance Tolerance (Code)	Temperature Coefficient (ppm/°C)	Resistance Range	Operating Temperature Range (°C)
NCSR100	2512	1 Watt	1	$\pm 1\%$ (F) $\pm 3\%$ (H) $\pm 5\%$ (J)	± 50 (D)* ± 75 (W)* ± 100 (E)* ± 150 (K)* ± 200 (F)*	0.5m Ω ~ 10m Ω	-55°C ~ +170°C
NCSR200		2 Watt	1			0.5m Ω ~ 10m Ω	
NCSR300		3 Watt	1			0.5m Ω ~ 10m Ω	

*See Part Number Tables for Available Value/ TCR, ** See Part Number Tables for Case Type

ENVIRONMENTAL CHARACTERISTICS

Item	Specification	Test Method
	Type 1	
Temperature Coefficient of Resistance	As Specified	MIL-STD-202, Method 304 +25/-55/+25/+125/+25°C
Thermal Shock	$\pm 0.5\%$	MIL-STD-202, Method 107G -55°C ~ +150°C, 100 cycles
Short Time Overload	$\pm 0.5\%$	JIS-C-5201-5.5 5x rated power for 5 seconds
Resistance to dry heat	$\pm 1\%$	JIS-C-5201-7.2 96 hrs @ 170°C without load
Load Life	$\pm 1\%$	MIL-STD-202 Method 108 RCWV @ 70°C, cycles of 1.5 hours on, 0.5 hrs off for 1,000 hrs
Resistance to Soldering Heat	$\pm 0.5\%$	MIL-STD-202 Method 210E 260°C $\pm 5^\circ\text{C}$ for 10 sec. ± 1 sec.
Solderability	95% min. coverage	MIL-STD-202 Method 208H 245°C $\pm 5^\circ\text{C}$ for 3 sec.

Operating Voltage: $\sqrt{\text{Power rating (Watts)} \times \text{Resistance (Ohms)}}$

Short Time Overload Voltage: $5x \sqrt{\text{Power rating (Watts)} \times \text{Resistance (Ohms)}}$

Operating Current: $\sqrt{\text{Power rating (Watts)} / \text{Resistance (Ohms)}}$

Power Derating Curve: For operation above 70°C, power rating must be derated according to the following chart:

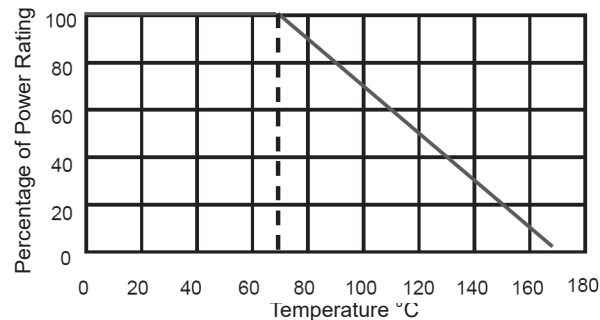

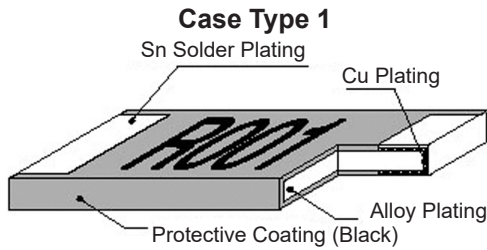

THERMAL EMF

Type	EIA Size	Power Rating	Case Type	Resistance Value	Thermal EMF
NCSR100	2512	1 Watt	1	0.5mΩ ~ 2mΩ	-1 μV/°C
NCSR200		2 Watt			
NCSR300		3 Watt		2.5mΩ ~ 10mΩ	+4 μV/°C

NCSR100 (1 WATT, 2512 CASE SIZE) AVAILABLE VALUES

Part Number	Resistance Value (mΩ)	Available Tolerance	Available TCR	Length (L)	Width (W)	Thickness (T)	Termination Width (P)	Case Type
NCSR100*M50DTRF	0.50	±1% (F) ±3% (H) ±5% (J)	±50ppm (D)	6.35±0.254	3.18 ±0.254	1.25 ± 0.20	1.30 ±0.38	1
NCSR100*M75DTRF	0.75					0.75 ± 0.20		
NCSR100*R001DTRF	1.0					0.65 ± 0.20		
NCSR100*1M50DTRF	1.5					0.45 ± 0.20		
NCSR100*R002DTRF	2.0					0.35 ± 0.20		
NCSR100*2M50KTRF	2.5		±150ppm (K)			0.65 ± 0.20		
NCSR100*R003KTRF	3.0		±100ppm (E)			0.55 ± 0.20		
NCSR100*R004ETRF	4.0		0.45 ± 0.20					
NCSR100*R005ETRF	5.0		0.35 ± 0.20					
NCSR100*R006WTRF	6.0		0.32 ± 0.20					
NCSR100*6M50WTRF	6.5		±75ppm (W)			0.30 ± 0.20		
NCSR100*R007WTRF	7.0		0.27 ± 0.20					
NCSR100*R010ETRF	10		±100ppm (E)			0.25 ± 0.20		

* Insert appropriate tolerance code

NCSR200 (2 WATT, 2512 CASE SIZE) AVAILABLE VALUES

Part Number	Resistance Value (mΩ)	Available Tolerance	Available TCR	Length (L)	Width (W)	Thickness (T)	Termination Width (P)	Case Type
NCSR200*M50DTRF	0.50	±1% (F) ±3% (H) ±5% (J)	±50ppm (D)	6.35±0.254	3.18 ±0.254	1.25 ± 0.20	1.30 ±0.38	1
NCSR200*M75DTRF	0.75					0.75 ± 0.20		
NCSR200*R001DTRF	1.0					0.65 ± 0.20		
NCSR200*1M50DTRF	1.5					0.45 ± 0.20		
NCSR200*R002DTRF	2.0					0.35 ± 0.20		
NCSR200*2M50KTRF	2.5		±150ppm (K)			0.65 ± 0.20		
NCSR200*R003KTRF	3.0		±100ppm (E)			0.55 ± 0.20		
NCSR200*R004ETRF	4.0		0.45 ± 0.20					
NCSR200*R005ETRF	5.0		0.35 ± 0.20					
NCSR200*R006WTRF	6.0		0.32 ± 0.20					
NCSR200*6M50WTRF	6.5		±75ppm (W)			0.30 ± 0.20		
NCSR200*R007WTRF	7.0		0.27 ± 0.20					
NCSR200*R010ETRF	10		±100ppm (E)			0.25 ± 0.20		

* Insert appropriate tolerance code

NCSR300 (3 WATT, 2512 CASE SIZE) TYPE 1 BLACK COATING AVAILABLE VALUES

Part Number	Resistance Value (mΩ)	Available Tolerance	Available TCR	Length (L)	Width (W)	Thickness (T)	Termination Width (P)	Case Type
NCSR300*M50DTRF	0.50	±1% (F) ±3% (H) ±5% (J)	±50ppm (D)	6.35±0.254	3.18 ±0.254	1.25 ± 0.20	1.30 ±0.38	1
NCSR300*M75DTRF	0.75					0.75 ± 0.20		
NCSR300*R001DTRF	1.0					0.65 ± 0.20		
NCSR300*1M50DTRF	1.5					0.45 ± 0.20		
NCSR300*R002DTRF	2.0					0.35 ± 0.20		
NCSR300*2M50KTRF	2.5		±150ppm (K)			0.65 ± 0.20		
NCSR300*R003KTRF	3.0					0.55 ± 0.20		
NCSR300*R004ETRF	4.0					0.45 ± 0.20		
NCSR300*R005ETRF	5.0		±100ppm (E)			0.35 ± 0.20		
NCSR300*R006WTRF	6.0					0.32 ± 0.20		
NCSR300*6M50WTRF	6.5		±75ppm (W)			0.30 ± 0.20		
NCSR300*R007WTRF	7.0					0.27 ± 0.20		
NCSR300*R010ETRF	10					0.25 ± 0.20		

* Insert appropriate tolerance code

PART NUMBER SYSTEM

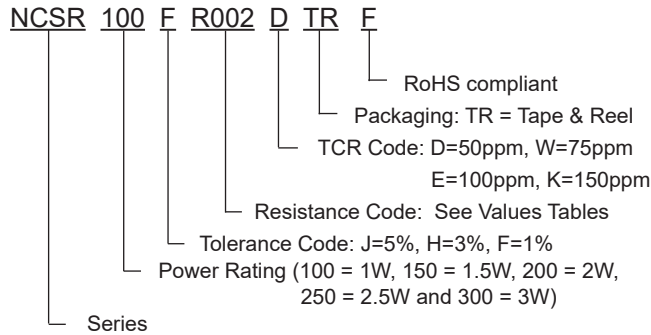

TYPE 1

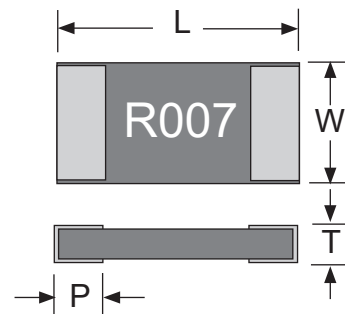

2512 TYPE 1 WITH BLACK COATING

2-WIRE LAND PATTERN DIM. (mm)
(no traces between pads to avoid short circuit)

Case Size	A	B	C
2512	2.70	2.95	3.6

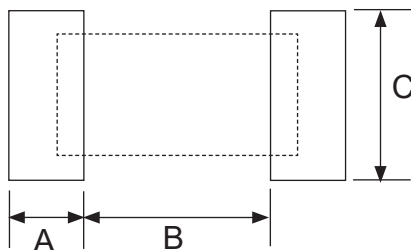

2512 TYPE 1 WITH BLACK COATING

4-WIRE LAND PATTERN DIM. (mm)
Recommended for precision current sensing
(no traces between pads to avoid short circuit)

Case Size	A	B	C	D
2512	2.70	2.95	1.45	1.00

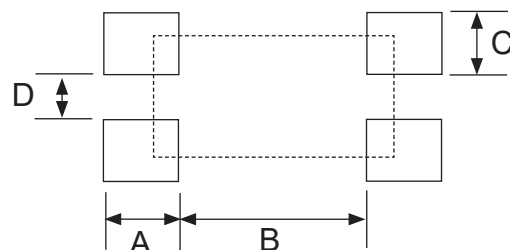

Reflow Soldering Heat Profile and Limits

→ www.niccomp.com/resource/files/resistive/NIC-ChipR-Reflow-Sept2020-Rev2.pdf
Wave soldering? – Please review your wave soldering process profile with NIC: tpmg@niccomp.com

TAPE DIMENSIONS (mm)

Case Size	Resistance Values	A	B	K	P	P ₁	E	F	D ₀	W	Quantity per Reel
				Case 1							
2512	0.50	3.40 ±0.1	6.75 ±0.1	1.45 ± 0.2	4.0 ±0.1	4.0 ±0.1	1.75 ±0.1	5.50 ±0.05	1.55 ±0.05	12.0 ±0.1	2,000
	0.75			0.81 ±0.1							
	1 ~ 10										

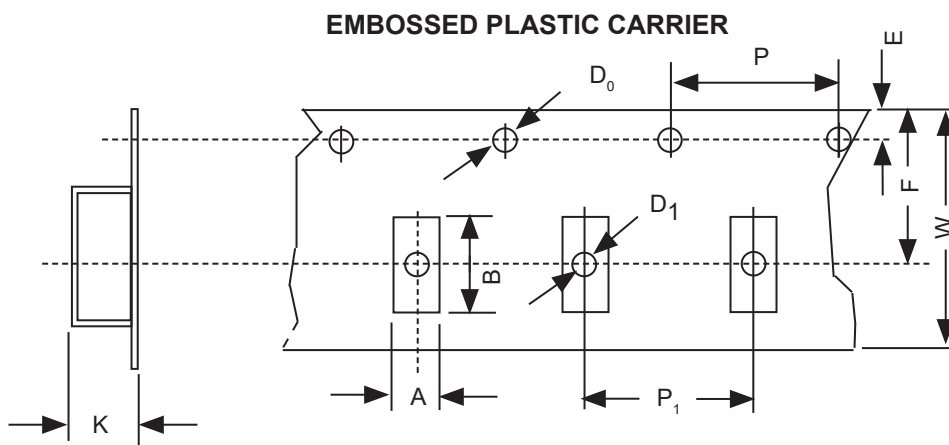

Notice:

1. The cumulative tolerance of 10 sprocket hole pitch is $\pm 0.2\text{mm}$.
2. Carrier camber shall be not more than 1mm per 100mm through a length of 250mm.
3. A & B measured 0.3mm from the bottom of the packet
4. K measured at a point on the inside bottom of the packet to the top surface of the carrier.
5. Pocket position relative to sprocket hole is measured as the true position of the pocket and not the pocket hole.