

NAZJ Series

Surface Mount Aluminum Electrolytic Capacitors



FEATURES

- CYLINDRICAL V-CHIP CONSTRUCTION FOR SURFACE MOUNTING
- REDUCED CASE SIZE (SMALLER THEN NAZT)
- LOW ESR & HIGH RIPPLE CURRENT AT 100KHz
- LOAD LIFE (2,000 HOURS @ +105°C)
- DESIGNED FOR AUTOMATIC MOUNTING AND REFLOW SOLDERING
- **MEETS THE REQUIREMENTS OF AEC-Q200*** (See Highlighted Items in Standard Values Table)

*Contact NIC for supporting test data

SAC Alloy Compatible
235°C ~ 260°C



CHARACTERISTICS

Rated Voltage Rating	6.3 ~ 50Vdc						
Rated Capacitance Range	10 ~ 1,800µF						
Operating Temp. Range	-55 ~ +105°C						
Capacitance Tolerance	±20% (M)						
Max. Leakage Current After 2 Minutes @ 20°C	0.01CV or 3µA whichever is greater						
Dissipation Factor	W.V. (Vdc)	6.3	10	16	25	35	50
	S.V. (Vdc)	8.0	13	20	32	44	63
	Tan δ @ 120Hz/20°C	0.26	0.19	0.16	0.14	0.12	0.10
Low Temperature Stability Impedance Ratio @ 120Hz	W.V. (Vdc)	6.3	10	16	25	35	50
	Z-25°C/Z+20°C	2	2	2	2	2	2
	Z-40°C/Z+20°C	3	3	3	3	3	3
	Z-55°C/Z+20°C	4	4	4	3	3	3
Load Life Test @ 105°C 2,000 hours	Capacitance Change	Within ±30% of initial measured value					
	Tan δ	Less than ±200% of the specified maximum value					
	Leakage Current	Less than the specified maximum value					

LOW ESR COMPONENT
LIQUID ELECTROLYTE
For Performance Data see www.LowESR.com

PART NUMBER SYSTEM

NAZJ 471 M 16V 8x10.5 N LB W Y E RoHS Compliant

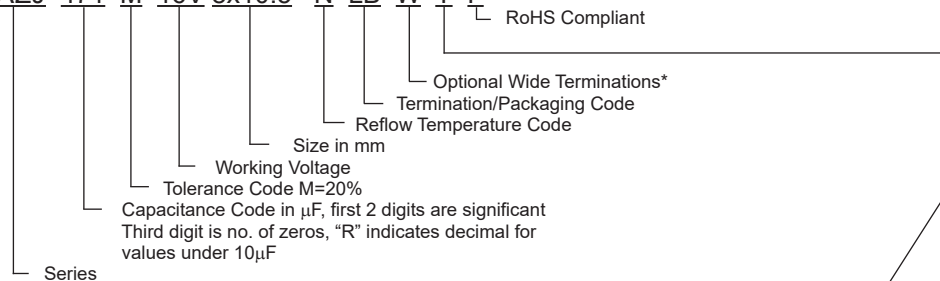

*Wide terminations available on 8mm & 10mm diameter parts.
See page 5 for details.

Optional: Suitable for automotive equipment, sourced to special production and inspection at IATF-16949 certified production site

NAZJ Series

Surface Mount Aluminum Electrolytic Capacitors



DIMENSIONS (mm)

Case Size	$\phi D \pm 0.5$	L max.	A ± 0.2	B ± 0.2	I ± 0.3	W	P ± 0.3
4x6.1	4.0	6.1	4.3	4.3	1.8	0.50~0.80	1.0
5x6.1	5.0	6.1	5.3	5.3	2.2	0.50~0.80	1.5
6.3x6.1	6.3	6.1	6.6	6.6	2.6	0.50~0.80	1.8
6.3x8	6.3	8.0	6.6	6.6	2.6	0.50~0.80	1.8
8x6.5	8.0	6.5	8.3	8.3	3.4	0.50~0.80	2.2
8x10.5	8.0	10.5	8.3	8.3	3.1	0.7~1.1	3.1
10x10.5	10.0	10.5	10.3	10.3	3.2	0.7~1.4	4.6
10x14	10.0	14.0	10.3	10.3	3.2	0.7~1.4	4.6

PEAK REFLOW TEMPERATURE CODES

Code	Peak Reflow Temperature
N	260°C*

*Special conditions on page 3.

TERMINATION FINISH & PACKAGING OPTIONS CODES

Code	Finish & Reel Size
B	Sn-Bi Finish & 13" Reel
LB	Sn-Bi Finish & 15" Reel

*See part number standard values table for appropriate code

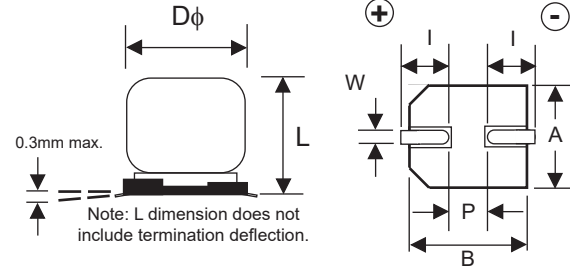

STANDARD VALUES, CASE SIZES AND SPECIFICATIONS

NIC Part Number	Cap. (μF)	W.V. (Vdc)	Dissipation Factor (Tan δ)	Max. ESR (Ω) 100KHz, +20°C	Max. Ripple Current (mA) +105°C, 100KHz	Load Life Hours @ +105°C
NAZJ220M6.3V4X6.1NLBF	22	6.3	0.26	0.85	160	2,000
NAZJ470M6.3V4X6.1NLBF	47		0.26	0.85	160	2,000
NAZJ470M6.3V5X6.1NLBF	47		0.26	0.36	240	2,000
NAZJ101M6.3V5X6.1NLBF	100		0.26	0.36	240	2,000
NAZJ101M6.3V6.3X6.1NLBF	100		0.26	0.26	300	2,000
NAZJ221M6.3V6.3X6.1NLBF	220		0.26	0.26	300	2,000
NAZJ331M6.3V6.3X8NLBF	330		0.26	0.16	600	2,000
NAZJ331M6.3V8X6.5NLBF	330		0.26	0.18	500	2,000
NAZJ471M6.3V8X10.5NLBF	470		0.26	0.08	850	2,000
NAZJ102M6.3V8X10.5NLBF	1000		0.26	0.08	850	2,000
NAZJ152M6.3V10X10.5NLBF	1500		0.26	0.06	1190	2,000
NAZJ182M6.3V10X10.5NLBF	1800		0.26	0.08	850	2,000
NAZJ220M10V4X6.1NLBF	22		10	0.19	0.85	160
NAZJ330M10V4X6.1NLBF	33	0.19		0.85	160	2,000
NAZJ330M10V5X6.1NLBF	33	0.19		0.36	240	2,000
NAZJ151M10V6.3X6.1NLBF	150	0.19		0.26	300	2,000
NAZJ221M10V6.3X8NLBF	220	0.19		0.16	600	2,000
NAZJ221M10V8X6.5NLBF	220	0.19		0.18	500	2,000
NAZJ331M10V8X10.5NLBF	330	0.19		0.08	850	2,000
NAZJ471M10V8X10.5NLBF	470	0.19		0.08	850	2,000
NAZJ681M10V8X10.5NLBF	680	0.19		0.08	850	2,000
NAZJ102M10V10X10.5NLBF	1000	0.19		0.06	1190	2,000
NAZJ122M10V10X10.5NLBF	1200	0.19		0.08	850	2,000
NAZJ152M10V10X14NLBF	1500	0.19		0.06	1190	2,000
NAZJ100M16V4X6.1NLBF	10	16		0.16	0.85	160
NAZJ220M16V4X6.1NLBF	22		0.16	0.85	160	2,000
NAZJ220M16V5X6.1NLBF	22		0.16	0.36	240	2,000
NAZJ470M16V5X6.1NLBF	47		0.16	0.36	240	2,000
NAZJ470M16V6.3X6.1NLBF	47		0.16	0.26	300	2,000
NAZJ680M16V6.3X6.1NLBF	68		0.16	0.26	300	2,000
NAZJ101M16V6.3X6.1NLBF	100		0.16	0.26	300	2,000
NAZJ101M16V6.3X8NLBF	100		0.16	0.16	600	2,000
NAZJ151M16V6.3X8NLBF	150		0.16	0.16	600	2,000
NAZJ221M16V6.3X8NLBF	220		0.16	0.16	600	2,000
NAZJ221M16V8X6.5NLBF	220		0.16	0.18	500	2,000
NAZJ331M16V8X10.5NLBF	330		0.16	0.08	850	2,000
NAZJ471M16V8X10.5NLBF	470		0.16	0.08	850	2,000
NAZJ681M16V10X10.5NLBF	680		0.16	0.06	1190	2,000
NAZJ821M16V10X10.5NLBF	820		0.16	0.08	850	2,000
NAZJ102M16V10X14NLBF	1000		0.16	0.06	1190	2,000

*Denotes Lower Reflow Temperature Rated, Lower Cost Alternative

Items in highlighted cells are available in automotive grade

Performance Passives By Design

NAZJ Series

Surface Mount Aluminum Electrolytic Capacitors



STANDARD VALUES, CASE SIZES AND SPECIFICATIONS

NIC Part Number	Cap. (μF)	W.V. (Vdc)	Dissipation Factor (Tan δ)	Max. ESR (Ω) 100KHz, +20°C	Max. Ripple Current (mA) +105°C, 100KHz	Load Life Hours @ +105°C	
NAZJ100M25V4X6.1NLBF	10	25	0.14	0.85	160	2,000	
NAZJ220M25V5X6.1NLBF	22		0.14	0.36	240	2,000	
NAZJ330M25V5X6.1NLBF	33		0.14	0.36	240	2,000	
NAZJ330M25V6.3X6.1NLBF	33		0.14	0.26	300	2,000	
NAZJ470M25V6.3X6.1NLBF	47		0.14	0.26	300	2,000	
NAZJ680M25V6.3X6.1NLBF	68		0.14	0.26	300	2,000	
NAZJ101M25V6.3X8NLBF	100		0.14	0.16	600	2,000	
NAZJ101M25V8X6.5NLBF	100		0.14	0.18	500	2,000	
NAZJ151M25V8X10.5NLBF	150		0.14	0.08	850	2,000	
NAZJ221M25V8X10.5NLBF	220		0.14	0.08	850	2,000	
NAZJ331M25V8X10.5NLBF	330		0.14	0.08	850	2,000	
NAZJ471M25V10X10.5NLBF	470		0.14	0.06	1190	2,000	
NAZJ561M25V10X10.5NLBF	560		0.14	0.08	850	2,000	
NAZJ681M25V10X14NLBF	680		0.14	0.06	1190	2,000	
NAZJ100M35V4X6.1NLBF	10	35	0.12	0.85	160	2,000	
NAZJ220M35V5X6.1NLBF	22		0.12	0.36	240	2,000	
NAZJ330M35V6.3X6.1NLBF	33		0.12	0.26	300	2,000	
NAZJ470M35V6.3X6.1NLBF	47		0.12	0.26	300	2,000	
NAZJ680M35V6.3X8NLBF	68		0.12	0.16	600	2,000	
NAZJ101M35V6.3X8NLBF	100		0.12	0.16	600	2,000	
NAZJ101M35V8X10.5NLBF	100		0.12	0.08	850	2,000	
NAZJ151M35V8X10.5NLBF	150		0.12	0.08	850	2,000	
NAZJ221M35V8X10.5NLBF	220		0.12	0.08	850	2,000	
NAZJ331M35V10X10.5NLBF	330		0.12	0.06	1190	2,000	
NAZJ391M35V10X10.5NLBF	390		0.12	0.08	850	2,000	
NAZJ471M35V10X14NLBF	470		0.12	0.06	1190	2,000	
NAZJ101M50V8X10.5NLBF	100		50	0.10	0.18	670	2,000
NAZJ221M50V10X10.5NLBF	220			0.10	0.12	900	2,000
NAZJ331M50V10X14NLBF	330	0.10		0.10	900	2,000	

*Denotes Lower Reflow Temperature Rated, Lower Cost Alternative

Items in highlighted cells are available in automotive grade



RIPPLE CURRENT FREQUENCY CORRECTION FACTOR (STANDARD)

Frequency	120Hz	1KHz	10KHz	100KHz ~
10 ~ 470 μ F	0.65	0.85	0.95	1.00
560 ~ 1800 μ F	0.75	0.90	0.95	1.00

RIPPLE CURRENT FREQUENCY CORRECTION FACTOR (ALTERNATIVE PART)

Frequency	120Hz	1KHz	10KHz	100KHz ~
100 ~ 150 μ F	0.50	0.80	0.95	1.00
220 ~ 1800 μ F	0.60	0.85	0.95	1.00

PEAK REFLOW TEMPERATURE, DURATION AND NUMBER OF REFLOW PASSES ALLOWED

Diameter	Reflow Code	Peak Temperature	Duration	Time above 200°C	Time above 217°C	Time above 230°C	Number of Reflow Passes
4 ~ 6.3mm ϕ	N	+260°C	Time \geq 250°C 5 sec.	70 sec.	40 sec.	30 sec.	2
	N	+255°C	Time \geq 250°C 10 sec.	70 sec.	40 sec.	30 sec.	2
8 ~ 10mm ϕ (see note 1)	N	+260°C	Time \geq 250°C 5 sec.	70 sec.	40 sec.	30 sec.	1 only
	N	+245°C	Time \geq 240°C 10 sec.	70 sec.	40 sec.	30 sec.	2

1. Only one (1) reflow pass is allowed for 8mm and 10mm diameter parts if the peak reflow temperature is +260°C.
2. In situations where two reflow passes is allowed the second reflow shall be at least one hour after natural cool to room temperature has occurred.

RECOMMENDED LAND PATTERN DIMENSIONS (mm)

Case Size	a	b	c
4x6.1	1.0	2.6	1.6
5x6.1	1.5	3.0	1.6
6x3x6.1 6.3x8	1.8	3.5	1.8
8x6.5	2.2	4.5	2.2
8x10.5	2.8	4.1	2.2
10x10.5 10x14	4.3	4.4	2.5

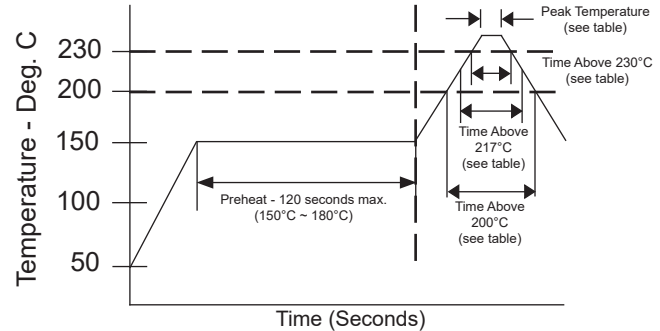
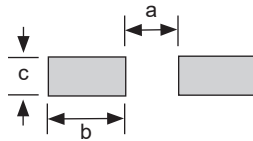

Review & Compare Reflow Soldering Heat Limits
V-chip SMT Aluminum Electrolytic Capacitors
www.niccomp.com/RSL

PRECAUTIONS

Please review the notes on correct use, safety and precautions found at <https://www.niccomp.com/resource/files/aluminum/AlumApplInfoCautions.pdf>
If in doubt or uncertainty, please review your specific application - process details with NIC's technical support personnel: tpmg@niccomp.com

WIDE TERMINATION (WT) DIM. (mm)

Case Size	$D\phi \pm 0.5$	L max.	A, B ± 0.2	C max.	P ref.	I ref.	W	R ± 0.2	T ± 0.2
8x6.5	8.0	6.8	8.3	9.5	(2.2)	3.4	0.6 ~ 0.8	0.7	1.7
8x10.5	8.0	11.2	8.3	10.0	(3.1)	3.4	0.7 ~ 1.1	0.7	1.3
10x10.5	10.0	11.2	10.3	12.0	(4.6)	3.5	0.7 ~ 1.4	0.7	1.3
10x14	10.0	14.5	10.3	12.0	(4.6)	3.5	1.0 ~ 1.4	0.7	1.3

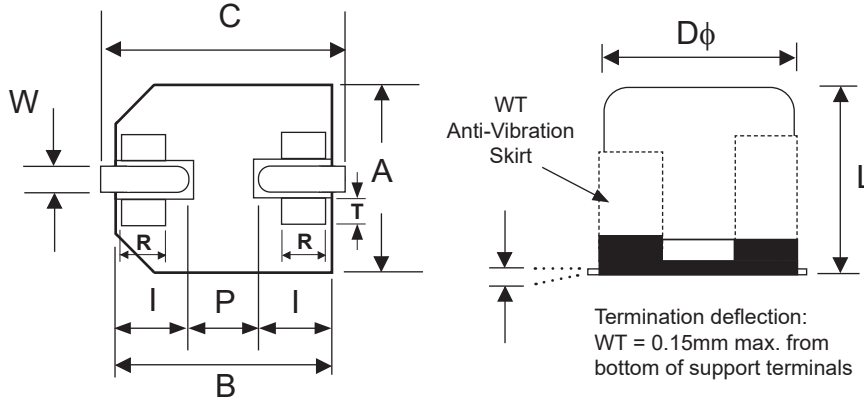

WT LAND PATTERN DIM. (mm)

Case Size	a	b	c
8x6.5	1.8	4.2	5.0
8x10.5	2.5	4.5	4.7
10x10.5	3.8	4.8	4.7
10x14	3.8	4.8	4.7

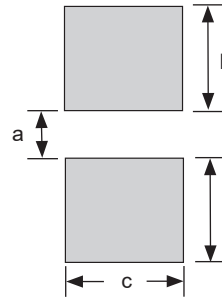

W (Wide Terminations) Anti-Vibration Test	
Test Method	Direction: X, Y, Z axis Frequency & Duration: 5 to 2000Hz reciprocation for 20 minutes, 2 hours each direction Peak to Peak Amplitude: 5mm Peak Acceleration: 30G Sweep Type: Log
Δ Capacitance	Within $\pm 10\%$ of initial value
Tangent of Loss	\leq Specified value
Leakage Current	\leq Specified value

CARRIER TAPE

Case Size	A ±0.3	B ±0.3	C ±0.3	D ±0.1	P ±0.1	T ±0.2
4 x 6.1	4.7	4.7	12.0	5.5	8.0	6.2
5 x 6.1	5.7	5.7	12.0	5.5	12.0	6.4
6.3 x 6.1	7.0	7.0	16.0	7.5	12.0	6.4
6.3 x 8	7.0	7.0	16.0	7.5	12.0	8.4
8 x 6.5	8.7	8.7	16.0	7.5	12.0	6.8
8 X 10.5	8.7	8.7	24.0	11.5	16.0	11.1
10 x 10.5	10.7	10.7	24.0	11.5	16.0	11.2
10 x 14	10.7	10.7	24.0	11.5	16.0	14.6

CARRIER

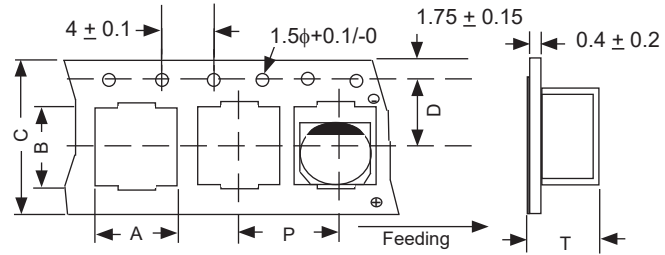

TAPING SPECIFICATIONS (mm)

- Both Leader and Trailer tape: Minimum 40mm (1.57") empty carrier tape pockets.
- Leader tape: Approximately 20cm of cover tape at leader.
- Connection: Maximum 3 connections (slices) per reel.

V-Chip 15" (380mm) Reels (LB suffix)

Dimensions (mm)

Case Size	Tape Width	W1	W2
6.3x6.1, 6.3x8	16.0	16.5 ~ 18.0	19.5 ~ 24.0
8x10.5, 10x10.5, 10x14	24.0	24.5 ~ 26.0	27.5 ~ 32.0

Case Size	Tape Width	A	B	C	D	E
6.3x6.1, 6.3x8	16.0	φ380 ±2	φ80~105	φ13 ±0.5	φ21 ±1.0	2.0 ±0.5
8x10.5, 10x10.5, 10x14	24.0					

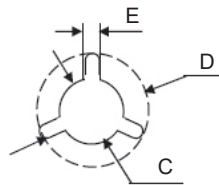
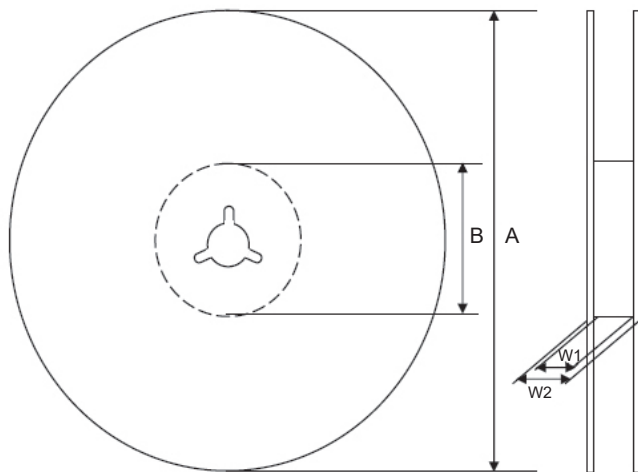

Case Size	Quantity Per Reel
	15" Reel
4x6.1	1,200 pcs
5x6.1	800 pcs
6.3x6.1	1,000 pcs
6.3x8	900 pcs
8x6.5	800 pcs
8x10.5	500 pcs
10x10.5	500 pcs
10x14	400 pcs