

NSTA Series

Surface Mount NTC Thermistors



FEATURES

- NEGATIVE TEMPERATURE COEFFICIENT
- FAST RESPONSE TO TEMPERATURE VARIATIONS MAKE THEM IDEALLY FOR TEMPERATURE SENSORS AND COMPENSATORS
- STANDARD EIA 0402 AND 0603 SIZES
- **MEETS THE REQUIREMENTS OF AEC-Q200**
- TAPE AND REEL FOR AUTOMATIC MOUNTING

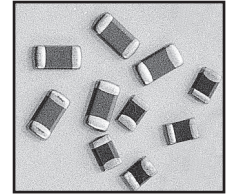

CHARACTERISTICS AND PERFORMANCE

Series	NSTA04	NSTA06
EIA Size	0402	0603
Resistance Range (+25°C)	10KΩ & 100KΩ	10KΩ & 100KΩ
Power Rating (+25°C)	125mW	125mW
Resistance Tolerance (+25°C)	F = 1%, H = ±3%, J = ±5%	
Operating Temperature Range	-40°C ~ 150°C	
Dissipation Factor	~1mW/°C	~1mW/°C
Thermal Time Constant	<3 Sec	<3 Sec.
Beta Temperature Range	D = +25°C ~ +50°C	
Beta Value Range	3380, 3950 & 4250	3380, 3585, 3950 & 4250
Beta Value Tolerance	F = 1%, H = ±3%	
Resistance to Soldering Heat +260°C for 5 seconds	Resistance Change ΔR ±1% for F tolerance parts ΔR ±3% for H tolerance parts ΔR ±5% for J tolerance parts Beta Change ΔBeta ±1% for F Beta tolerance parts ΔBeta ±3% for H Beta tolerance parts	
Damp Heat 1000hrs @ +60°C, 90~95%RH		
Thermal Shock -55°C (30 min.), within 20 seconds to +150°C (30 min.), 100 cycles		
Life Test 1,000hrs @ +15°C with maximum operating current applied		
High Temperature Storage 1000hrs @ +150°C, 90~95%RH		

DIMENSIONS (mm)

Series	EIA Size	L	W	T	P
NSTA04	0402	1.00 ± 0.15	0.50 ± 0.15	0.50 ± 0.15	0.25 ± 0.10
NSTA06	0603	1.60 ± 0.15	0.80 ± 0.15	0.80 ± 0.15	0.40 ± 0.20

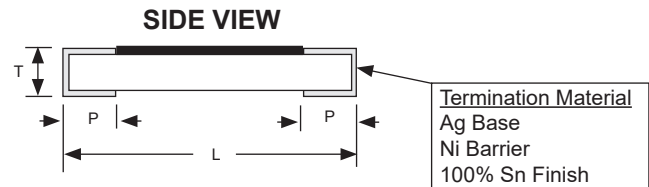

PART NUMBER SYSTEM

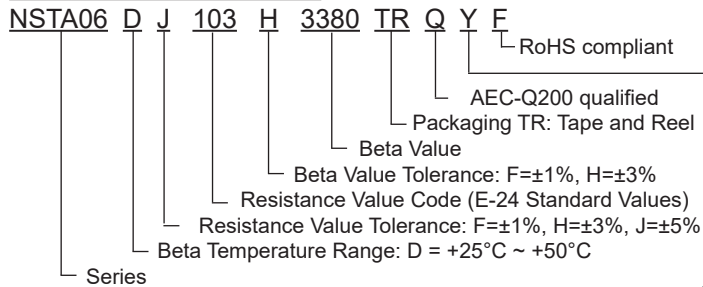

"Y" denotes suitable for automotive equipment, sourced to special production and inspection at IATF-16949 certified production site

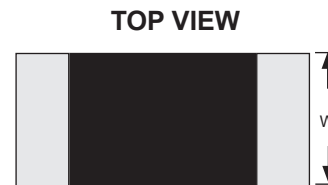

Beta Temperature Range 25/50	Beta Value			
		3380	3585	3950
Beta over 25/85	3435	3640	3990	4311

NSTA Series

Surface Mount NTC Thermistors



NSTA04 (0402 CASE SIZE) STANDARD VALUES AND SPECIFICATIONS

NSTA04 Part Number	Resistance Value +25°C	Beta Value (B25/50)	Beta Value (B25/85)	Maximum Operating Current (mA)	Termal Time CoNSTAant (sec.)	Dissipation Factor (mW/°C)	Rated Power (mW)
NSTA04D_103_3380TRQYF	10K	3380	3435	0.31	<3sec	~1	125
NSTA04D_103_3950TRQYF	10K	4250	3990	0.31			
NSTA04D_104_4250TRQYF	100K	4250	4311	0.10			

After D beta temperature range code: _ Insert resistance tol. code (F=1%, H=±3%, J=±5%)

After nominal resistance value: _ Insert beta tolerance code (F = 1%, H = ±3%)

NSTA04 R-T CURVES

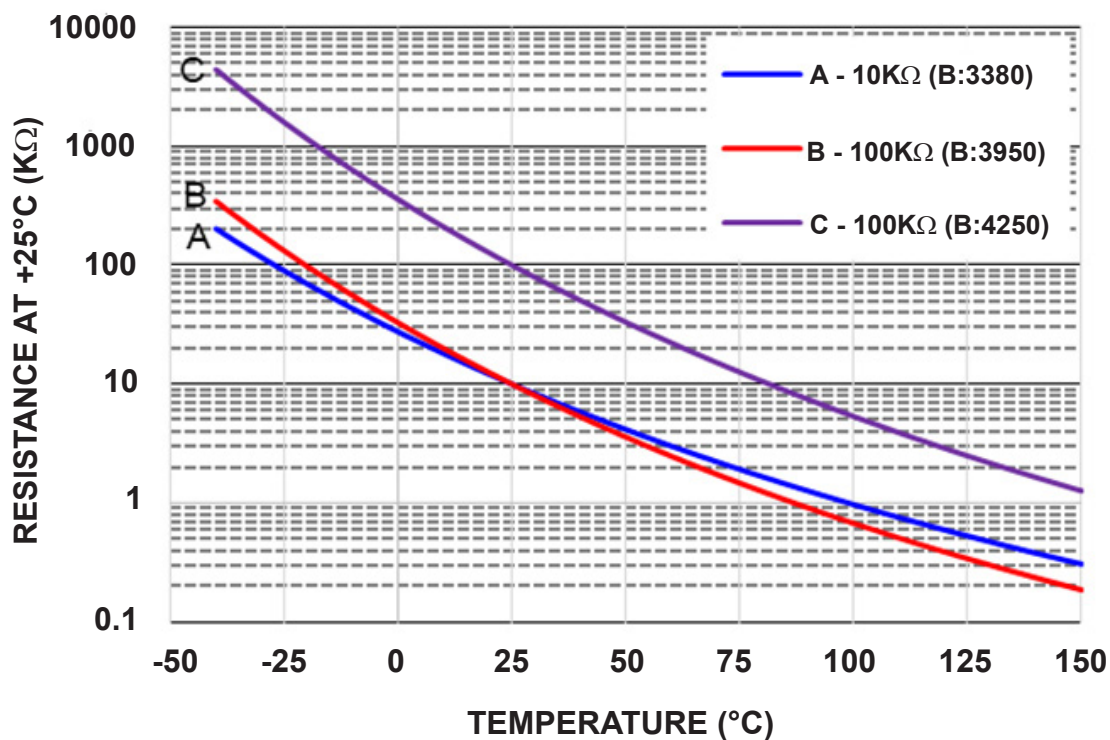

NSTA Series

Surface Mount NTC Thermistors



NSTA06 (0603 CASE SIZE) STANDARD VALUES AND SPECIFICATIONS

NSTA04 Part Number	Resistance Value +25°C	Beta Value (B25/50)	Beta Value (B25/85)	Maximum Operating Current (mA)	Thermal Time CoNSTAant (sec.)	Dissipation Factor (mW/°C)	Rated Power (mW)
NSTA06D_103_3380TRQYF	10K	3380	3435	0.31	<3sec	~1	125
NSTA06D_103_3585TRQYF	10K	3585	3640	0.31			
NSTA06D_103_3950TRQYF	10K	3950	3990	0.31			
NSTA06D_104_4250TRQYF	100K	4250	4311	0.10			

After D beta temperature range code: _ Insert resistance tol. code (F=1%, H=±3%, J=±5%)

After nominal resistance value: Insert beta tolerance code (F = 1%, H = ±3%)

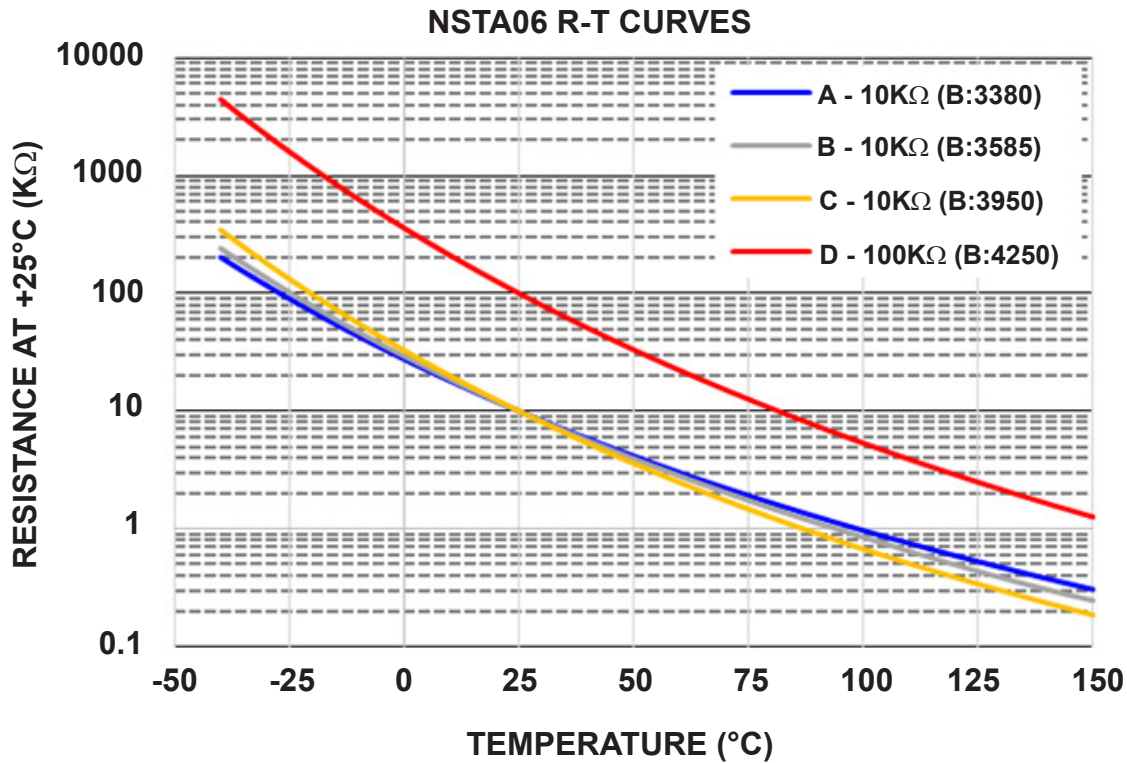

NSTA Series

Surface Mount NTC Thermistors



LAND PATTERN DIMENSIONS (mm)

Type	A	B	C
NSTA04	0.45 ~ 0.55	0.40 ~ 0.50	0.45 ~ 0.55
NSTA06	0.60 ~ 0.80	0.60 ~ 0.80	0.60 ~ 0.80

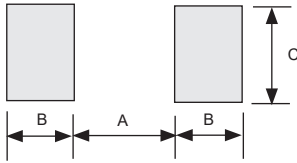

RECOMMENDED REFLOW SOLDERING TEMPERATURE PROFILE

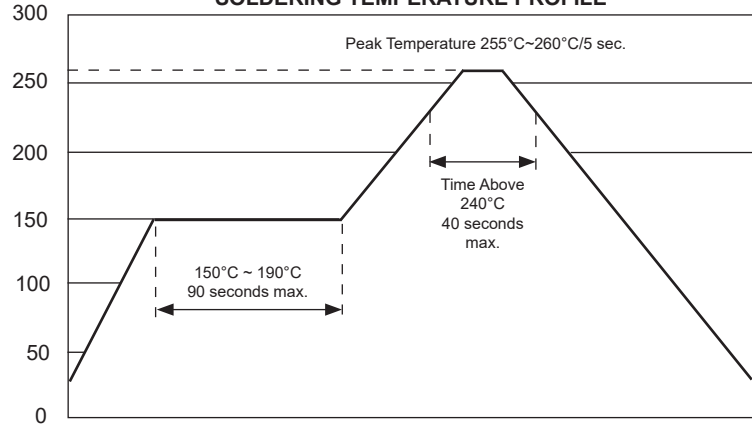

CARRIER TAPE DIMENSIONS (mm)

Type	A	B	W	F	E	P ₁	P ₀	φD	T ₁
NSTA04	0.65 ± 0.05	1.15 ± 0.05	8.00 ± 0.30	3.50 ± 0.05	1.75 ± 0.10	2.00 ± 0.05	4.00 ± 0.10	1.5 + 0.1/-0	0.80 max
NSTA06	1.00 ± 0.10	1.80 ± 0.10				4.00 ± 0.10			1.10 max.

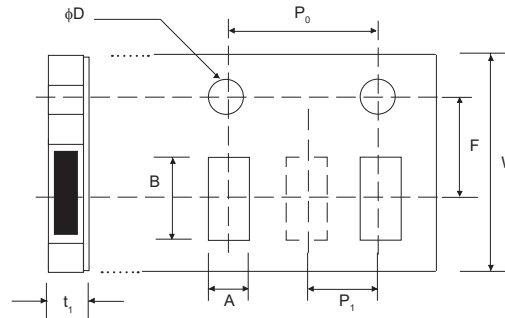

REEL DIMENSIONS (mm) AND QUANTITY

Type	A ± 2.0	B ± 2.0	C ± 0.20	W ± 1.5	Quantity
NSTA04	178	58	13.5	10.0	10,000
NSTA06					4,000

