

Hybrid Aluminum Electrolytic Capacitors

NSPE-A Series

- CYLINDRICAL V-CHIP CONSTRUCTION FOR SURFACE MOUNTING
- EXTENDED LOAD LIFE AT HIGH TEMPERATURE (10,000 HOURS @ +105°C)
- HIGH VOLTAGE RATINGS (25 ~ 80VDC)
- LOW ESR AND HIGH RIPPLE CURRENT RATINGS
- 5x6.1mm ~ 10x10.5mm CASE SIZES
- REFLOW SOLDERING RATED UP TO +260°C
- MEETS THE REQUIREMENTS OF AEC-Q200*

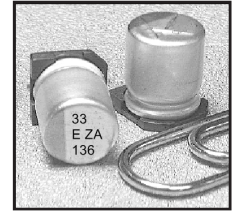

RoHS Compliant
 includes all homogeneous materials
 *See Part Number System for Details
Available with Wide Anti-Vibration Terminations

CHARACTERISTICS

Rated Voltage Range	25 ~ 80Vdc					
Rated Capacitance Range	10 ~ 330μF					
Operating Temp. Range	-55 ~ +105°C					
Capacitance Tolerance	±20% (M)					
Max. Leakage Current After 2 Minutes @ 20°C	Less than 0.01CV or 3μA whichever is greater					
Working and Surge Voltage Ratings	W.V. (Vdc)	25	35	50	63	80
	S.V. (Vdc)	32	44	63	79	100
Tan δ @ 120Hz/20°C		0.14	0.12	0.10	0.08	0.08
Impedance Ratio	Z -25°C/Z +20°C	2				
	Z -55°C/Z +20°C	2.5				
Load Life Test @ 105°C and Rated Voltage (10,000 hours)	Capacitance Change	Within ±30% of initial measured value				
	Tan δ and ESR	Less than 200% of specified max. value				
	Leakage Current	Less than specified max. value				

STANDARD PRODUCTS AND CASE SIZES Dφ x L (mm)

PART NUMBER	Cap. (μF)	Working Voltage	Case Size (D X L) mm	Max. Tan δ 120Hz/20°C	Max. ESR (mΩ) AT 100KHz/20°C	Max. Ripple Current (mA rms) AT 100KHz/105°C	Load Life Hours
NSPE-A330M25V5X6.1NLBYF	33	25	5X6.1	0.14	80	900	10,000
NSPE-A560M25V6.3X6.1NLBYF	56		6.3X6.1	0.14	50	1300	10,000
NSPE-A101M25V6.3X8NLBYF	100		6.3x8	0.14	30	2000	10,000
NSPE-A221M25V8X10.5NLBYF	220		8x10.5	0.14	27	2300	10,000
NSPE-A331M25V10X10.5NLBYF	330		10x10.5	0.14	20	2500	10,000
NSPE-A220M35V5X6.1NLBYF	22	35	5X6.1	0.12	100	900	10,000
NSPE-A270M35V6.3X6.1NLBYF	27		6.3X6.1	0.12	60	1300	10,000
NSPE-A470M35V6.3X6.1NLBYF	47		6.3X6.1	0.12	60	1300	10,000
NSPE-A680M35V6.3X8NLBYF	68		6.3x8	0.12	35	2000	10,000
NSPE-A151M35V8X10.5NLBYF	150		8x10.5	0.12	27	2300	10,000
NSPE-A271M35V10X10.5NLBYF	270		10x10.5	0.12	20	2500	10,000
NSPE-A100M50V5X6.1NLBYF	10	50	5X6.1	0.1	120	750	10,000
NSPE-A220M50V6.3X6.1NLBYF	22		6.3X6.1	0.1	80	1100	10,000
NSPE-A330M50V6.3X8NLBYF	33		6.3X8	0.1	40	1600	10,000
NSPE-A680M50V8X10.5NLBYF	68		8X10.5	0.1	30	1800	10,000
NSPE-A101M50V10X10.5NLBYF	100		10X10.5	0.1	28	2000	10,000
NSPE-A100M63V6.3X6.1NLBYF	10	63	6.3X6.1	0.08	120	1000	10,000
NSPE-A220M63V6.3X8NLBYF	22		6.3X8	0.08	80	1500	10,000
NSPE-A330M63V8X10.5NLBYF	33		8X10.5	0.08	40	1700	10,000
NSPE-A560M63V10X10.5NLBYF	56		10X10.5	0.08	30	1800	10,000
NSPE-A220M80V8X10.5NLBYF	22	80	8x10.5	0.08	45	1550	10,000
NSPE-A330M80V10X10.5NLBYF	33		10X10.5	0.08	36	1700	10,000

RIPPLE CURRENT FREQUENCY CORRECTION FACTORS

Frequency	120Hz	1KHz	10KHz	100KHz
Correction Factor	0.1	0.3	0.60	1.00

PRECAUTIONS

Please review the notes on correct use, safety and precautions found on pages T10 & T11 of NIC's Electrolytic Capacitor catalog.
 Also found at www.niccomp.com/precautions
 If in doubt or uncertainty, please review your specific application - process details with NIC's technical support personnel: tpmg@niccomp.com



PART NUMBER SYSTEM

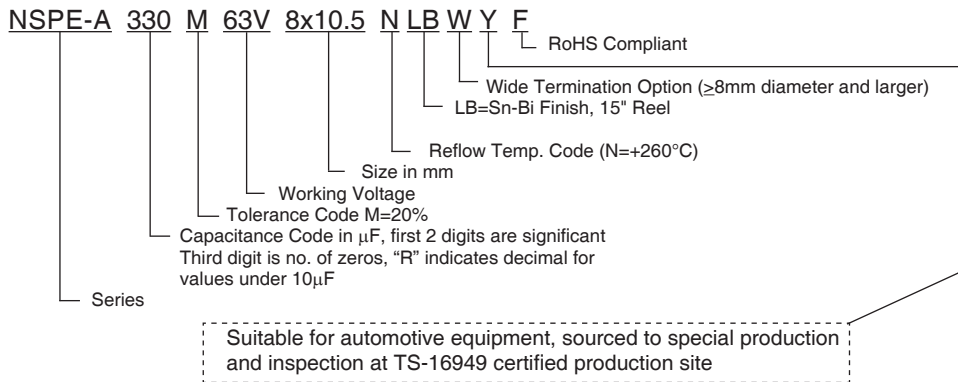

DIMENSIONS (mm)

Case Size	D ϕ ± 0.5	L max.	A, B ± 0.2	W	I ± 0.2	P ± 0.2
5X6.1	5	6.1	5.3	0.55 ~ 0.75	2.2	1.5
6.3X6.1	6.3	6.1	6.6	0.55 ~ 0.75	2.6	1.8
6.3X8	6.3	8.0	6.6	0.55 ~ 0.75	2.6	1.8
8X10.5	8.0	10.5	8.3	0.7 ~ 1.1	3.4	3.1
10X10.5	10	10.5	10.3	0.7 ~ 1.1	3.5	4.6

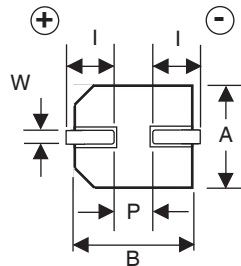
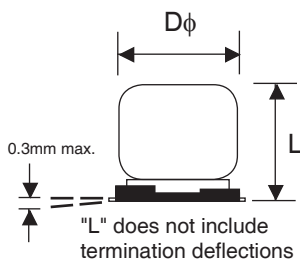

Part Marking

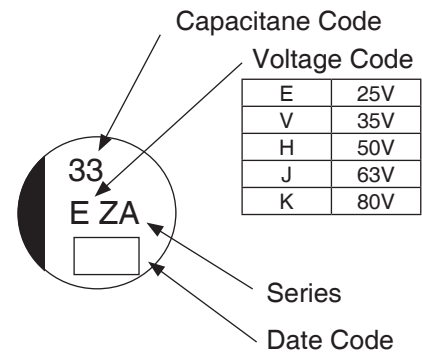

PEAK TEMPERATURE AND DURATION

Diameter	Time above 200°C	Time above 217°C	Time above 230°C	Duration at Temperature	Peak Temperature	Allowable Reflow Passes
$\phi 5 \sim 6.3\text{mm}$	70 sec. max.	40 sec. max.	30 sec. max.	$\geq 250^\circ\text{C} = 5 \text{ sec.}$	260°C	2
				$\geq 250^\circ\text{C} = 10 \text{ sec.}$	255°C	2
$\phi 8 \sim 10\text{mm}$				$\geq 250^\circ\text{C} = 5 \text{ sec.}$	260°C	1
				$\geq 240^\circ\text{C} = 10 \text{ sec.}$	245°C	2

For $\phi 5 \sim 6.3\text{mm}$ diameter parts:

- If peak temperature is $+260^\circ\text{C}$ the maximum time above $+250^\circ\text{C}$ is 5 seconds (maximum of two reflow passes).
- If peak temperature is $+255^\circ\text{C}$ the maximum time above $+250^\circ\text{C}$ is 10 seconds (maximum of two reflow passes).

For $\phi 8 \sim 10\text{mm}$ diameter parts:

- If peak temperature is $+260^\circ\text{C}$ the maximum time above $+250^\circ\text{C}$ is 5 seconds (maximum of one reflow pass).
- If peak temperature is $+245^\circ\text{C}$ the maximum time above $+240^\circ\text{C}$ is 10 seconds (maximum of two reflow passes).

RECOMMENDED REFLOW SOLDERING PROFILE*

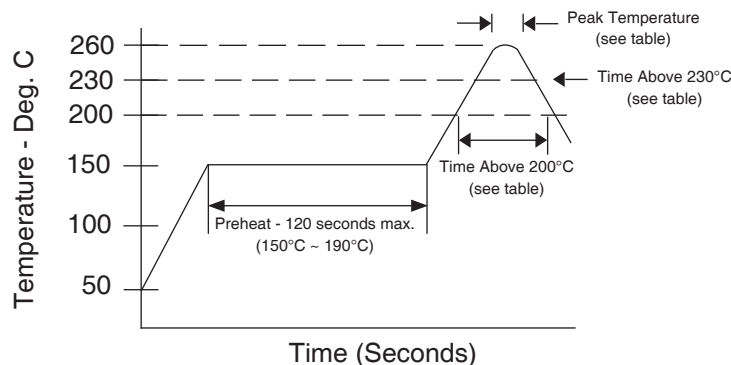

STANDARD TERMINATION LAND PATTERN DIM. (mm)

Case Diameter	A	B	C
5	1.5	2.8	1.6
6.3	1.8	3.2	1.6
8	3.1	4.0	2.0
10	4.6	4.1	2.0

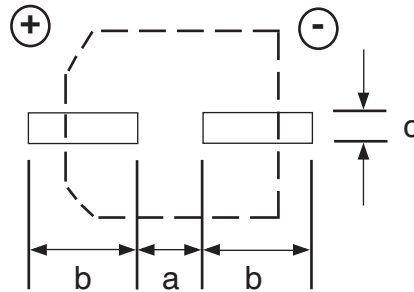

WIDE TERMINATION DIM. (mm)

Case Size	D ϕ \pm 0.5	L max.	A, B	C max.	P	W	R	T
6.3x6.1WT	6.3	6.4	6.6 \pm 0.2	7.8	(2.2)	0.65 \pm 0.1	(1.3 \pm 0.2)	(3.0 \pm 0.2)
6.3x8WT	6.3	8.3	6.6 \pm 0.2	7.8	(2.2)	0.65 \pm 0.1	(1.3 \pm 0.2)	(3.0 \pm 0.2)
8 x 10.5WT	8.0	10.8	8.3 \pm 0.2	10.0	(3.1)	1.2 \pm 0.2	0.7 \pm 0.2	1.3 \pm 0.2
10 x 10.5WT	10.0	10.8	10.3 \pm 0.2	12.0	(4.6)	1.2 \pm 0.2	0.7 \pm 0.2	1.3 \pm 0.2

WIDE TERMINATION LAND PATTERN DIM. (mm)

Case Size	a	b	c
6.3x6.1	1.2	3.6	3.2
6.3x8	1.2	3.6	3.2
8x10.5	2.5	4.5	4.7
10x10.5	3.8	4.8	4.7

6.3mm DIAMETER WT STYLE TERMINATION

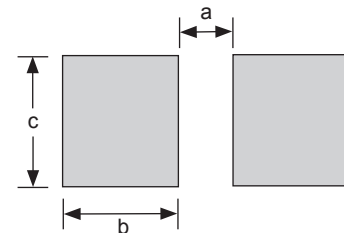
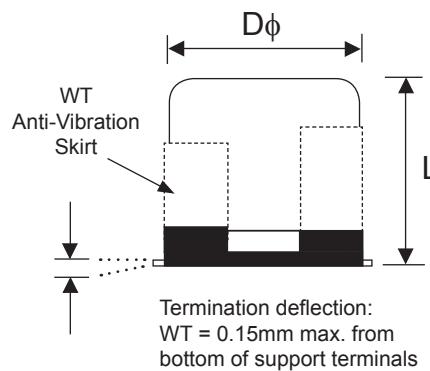
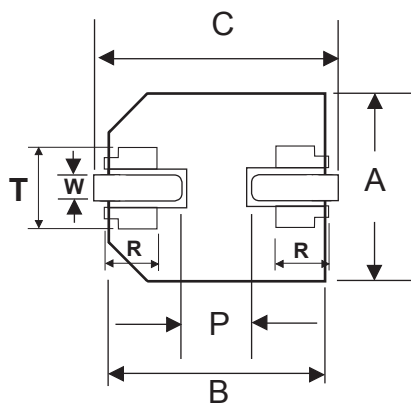

8 & 10mm DIAMETER WT STYLE TERMINATION

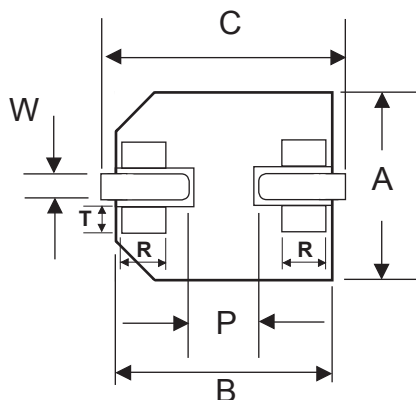

Review & Compare Reflow Soldering Heat Limits
V-chip SMT Aluminum Electrolytic Capacitors
www.niccomp.com/RSL



TAPING SPECIFICATIONS (mm)

- Both Leader and Trailer tape: Minimum 40mm (1.57") empty carrier tape pockets.
- Leader tape: Approximately 20cm of cover tape at leader.
- Connection: Maximum 3 connections (slices) per reel.

Case Size	A ±0.5	B ±0.5	C ±0.3	D ±0.1	P ±0.1	T ±0.2	t max.
5X6.1	5.7	5.7	12.0	5.5	12.0	6.4	0.4
6.3X6.1	7.0	7.0	16.0	7.5	12.0	6.4	0.4
6.3X8	7.0	7.0	16.0	7.5	12.0	8.4	0.4
8X10.5	8.7	8.7	24.0	11.5	16.0	11.0	0.4
10X10.5	10.7	10.7	24.0	11.5	16.0	11.0	0.4

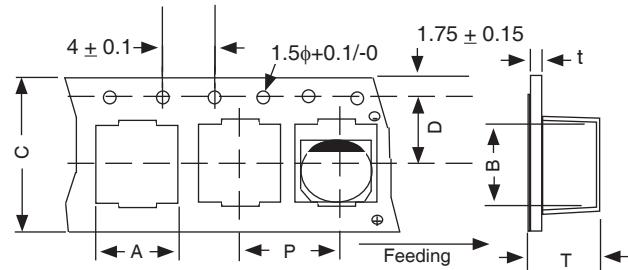

REEL DIMENSIONS (mm)

Case Size	W ±1.0	Qty per Reel
		15" (380mm)
5X6.1	14	1,000
6.3X6.1	18	1,000
6.3X8	18	900
8X10.5	26	500
10X10.5	26	500

