

FEATURES

- SUPER MINIATURE SIZE AND LOW PROFILE
- HIGH DENSITY PACKAGING OFFERS SIGNIFICANT SPACE SAVINGS
- LOWER PRODUCTION COSTS WITH LESS PLACEMENT (UP TO 8 RESISTORS IN ONE PACKAGE)
- STANDARD FOOTPRINTS MAKE CONVERSIONS EASY
- BOTH FLOW AND REFLOW SOLDERING APPLICABLE

RoHS Compliant
includes all homogeneous materials

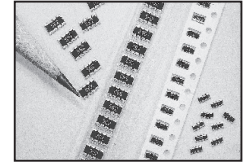

*See Part Number System for Details

SPECIFICATIONS

Type	NRSNØ4I2		NRSNA4I2		NRSNA6I2	NRSNØ4I4	NRSNA4I4	NRSNØ6I4	NRSNA6I4
Termination Type	Concave		Convex		Convex	Concave	Convex	Concave	Convex
Size W x L (mm)	1.0 x 1.0		1.0 x 1.0		1.6 x 1.6	1.0 x 2.0	1.0 x 2.0	1.6 x 3.2	
No. of Resistors & Circuit	2R Isolated		2R Isolated		2R Isolated	4R Isolated	4R Isolated	4R Isolated	
Power Rating per Resistor @ +70°C	1/16 (.0625W)		1/16 (.0625W)		1/16 (.0625W)	1/16 (.0625W)	1/16 (.0625W)	1/16 (.0625W)	
Resistance Tolerance	J(±5%) F(±1%)	J(±5%) F(±1%)	J(±5%) G(±2%) F(±1%)	J(±5%) G(±2%) F(±1%)	J(±5%) G(±2%) F(±1%)	J(±5%) F(±1%)	J(±5%) G(±2%) F(±1%)	J(5%) G(2%) F(±1%)	
Resistance Range	1Ω ~ 9.1Ω	10Ω ~ 1MΩ	1Ω ~ 9.1Ω	10Ω ~ 1MΩ	10Ω ~ 1MΩ	1Ω ~ 1MΩ	10Ω ~ 1MΩ	10Ω ~ 1MΩ	
Temperature Coefficient	±650ppm	±250ppm	±650ppm	±250ppm	±200ppm	±200ppm	±200ppm	±200ppm	
Maximum Working Voltage*	25V				50V	25V		50V	
Maximum Overload Voltage	50V				100V	50V		100V	
Operating Temperature Range	-55°C ~ +125°C (derated as shown)								

Type	NRSNØ6C NRSNØ6D	NRSN12I4	
Termination Type	Concave	Concave	
Size W x L (mm)	3.1 x 6.4	3.0 x 5.1	
No. of Resistors & Circuit	8R Common	4R Isolated	
Power Rating per Resistor @ +70°C	1/8 (0.125W)	1/8 (0.125W)	
Resistance Tolerance	J (5%)	J (5%)	G (2%)
Resistance Range	100Ω ~ 470KΩ	10Ω ~ 1MΩ	47Ω ~ 1MΩ
Temperature Coefficient	±200ppm	±200ppm	±200ppm
Maximum Working Voltage*	50V	75V	
Maximum Overload Voltage	100V	125V	
Operating Temperature Range	-55°C ~ +125°C (derated as shown)		

* Maximum allowable continuous voltage for all resistors is the lower of the two values: "MAXIMUM WORKING VOLTAGE" as specified, or

$$\sqrt{\text{Power rating (WATTS)} \times \text{Resistance (OHMS)}}$$

PART NUMBER SYSTEM (E-24 VALUES)

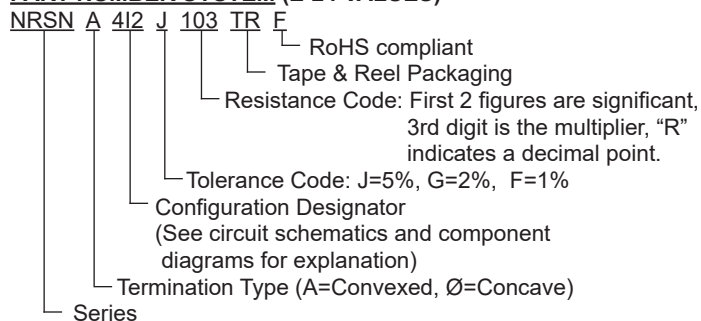

PART NUMBER SYSTEM (E-96 VALUES)

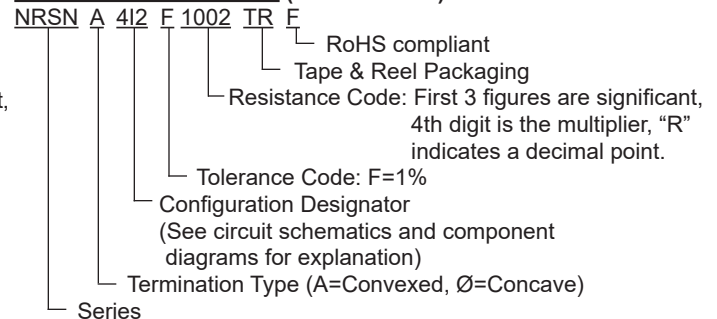

CIRCUIT SCHEMATICS

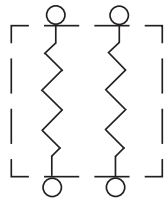

NRSNA412/Ø412
NRSNA612
Circuit Type "I"
Isolated

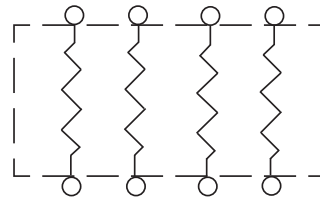

NRSNA414/Ø41
NRSNA611/Ø61 & NRSN121
Circuit Type "I"
Isolated

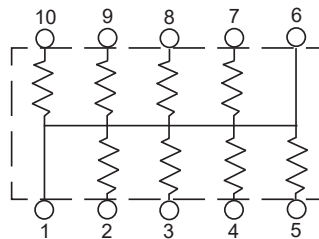

NRSNØ6C8
Circuit Type "C"
Bussed/Common

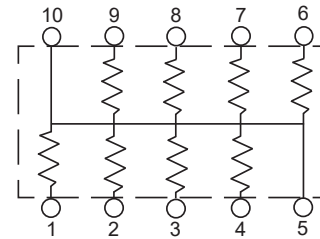

NRSNØ6D8
Circuit Type "D"
Bussed/Common

Power Derating Curve: For operation above 70°C, power rating must be derated according to the following chart:

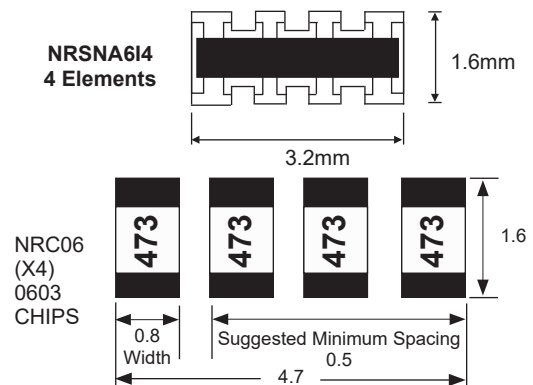
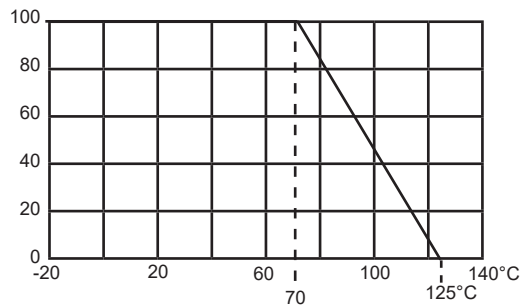

ZERO OHM PART DIMENSIONS (mm) (Resistance <0.50 ohms)

Type	Term. Type	Current Rating (per element)	W	L	P	T	A ₁	A ₂	B	C
NRSNA4I2ZOTRF	Convex	1.0A*	1.00 ± 0.20	1.00 ± 0.10	0.67 nom.	0.30 ± 0.05	0.33 ± 0.10	-	0.15 ± 0.10	0.25 ± 0.10
NRSNØ4I2ZOTRF	Concave	0.5A	1.00 ± 0.20	1.00 ± 0.10	0.50 nom.	0.30 ± 0.10	0.30 ± 0.10	-	0.20 ± 0.10	0.25 ± 0.10
NRSNA6I2ZOTRF	Convex	0.5A	1.6 ± 0.15	1.6 ± 0.15	0.76 nom.	0.45 ± 0.10	0.46 ± 0.10	-	0.30 ± 0.20	0.30 ± 0.10
NRSNA4I4ZOTRF	Convex	1.0A*	1.00 ± 0.20	2.00 ± 0.10	0.50 nom.	0.40 ± 0.10	0.30 ± 0.10	0.40 ± 0.10	0.20 ± 0.10	0.25 ± 0.10
NRSNØ4I4ZOTRF	Concave	1.0A*	1.00 ± 0.20	2.00 ± 0.10	0.50 nom.	0.40 ± 0.10	0.30 ± 0.10	-	0.15 ± 0.10	0.25 ± 0.10
NRSNA6I4ZOTRF	Convex	1.0A	1.60 ± 0.15	3.20 ± 0.20	0.80 nom.	0.50 ± 0.10	0.45 ± 0.10	0.60 ± 0.10	0.30 ± 0.15	0.30 ± 0.15
NRSNØ6I4ZOTRF	Concave	1.0A	1.60 ± 0.15	3.20 ± 0.20	0.80 nom.	0.55 ± 0.10	0.50 ± 0.10	-	0.35 ± 0.15	0.45 ± 0.15
NRSN12I4ZOTRF	Concave	1.5A	3.00 ± 0.20	5.08 ± 0.20	1.27 ± 0.20	0.70 ± 0.20	0.80 ± 0.20	-	0.60 ± 0.20	0.60 ± 0.20

*1.0A rating effective for production starting November 2015

COMPONENT MARKING

- NRSNØ4I2ZOTRF - (no markings)
- NRSNA4I2ZOTRF - (no markings)
- NRSNØ4I4ZOTRF - (no markings)
- NRSNA4I4ZOTRF - (marked "000")
- NRSN6I2AZOTRF - (marked "000")
- NRSNØ6I4ZOTRF - (marked "000")
- NRSNA6I4ZOTRF - (marked "000")
- NRSN12I4ZOTRF - (marked "000")

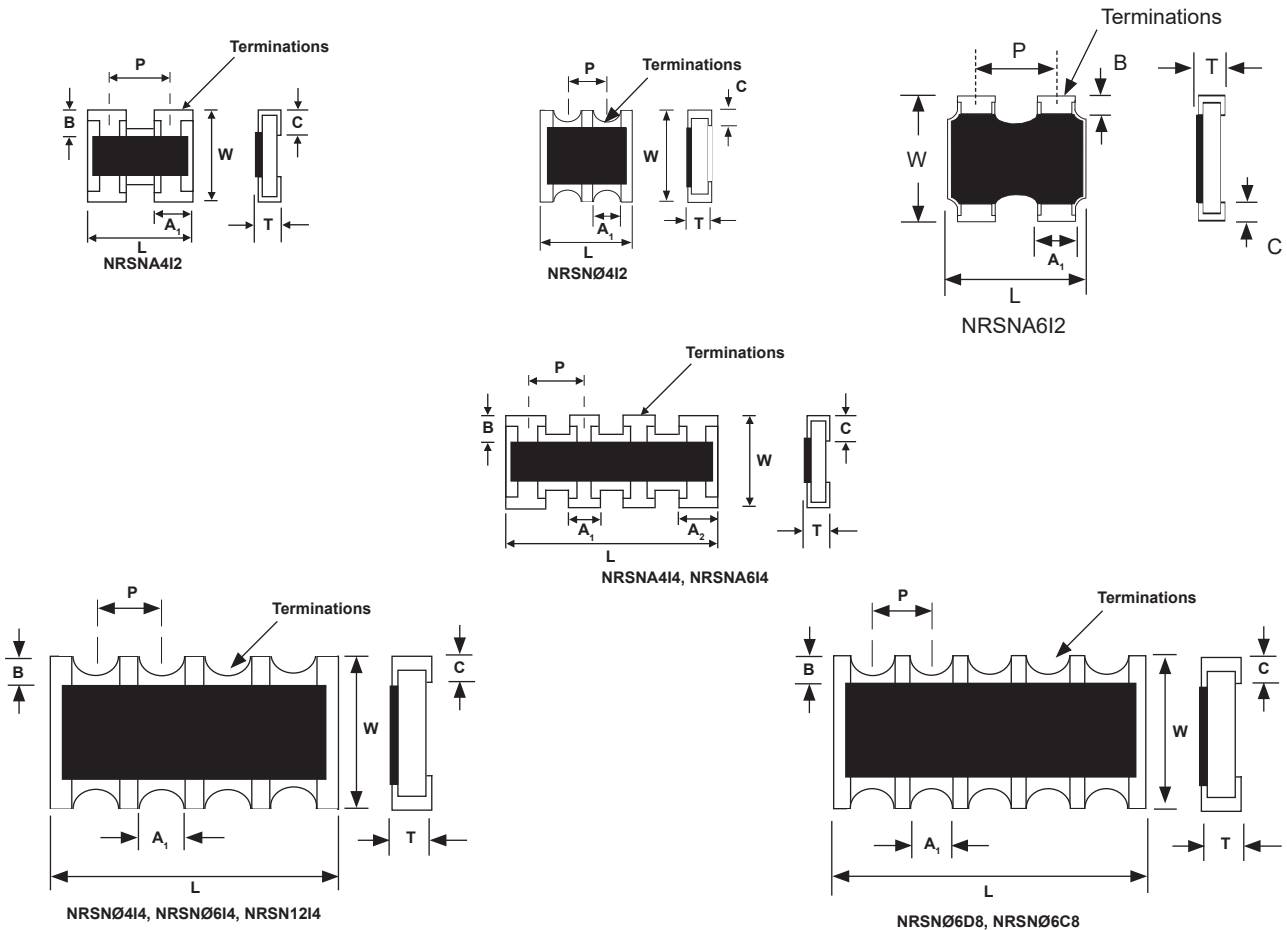

PART DIMENSIONS (mm)

Type	W	L	P	T	A ₁	A ₂	B	C
NRSNA4I2	1.00 ± 0.20	1.00 ± 0.10	0.67 nom.	0.30 ± 0.05	0.33 ± 0.10	-	0.15 ± 0.10	0.25 ± 0.10
NRSNØ4I2	1.00 ± 0.20	1.00 ± 0.10	0.50 nom.	0.30 ± 0.10	0.30 ± 0.10	-	0.20 ± 0.10	0.25 ± 0.10
NRSNA6I2	1.6 ± 0.15	1.6 ± 0.15	0.76 nom.	0.45 ± 0.10	0.46 ± 0.10	-	0.30 ± 0.20	0.30 ± 0.10
NRSNA4I4	1.00 ± 0.20	2.00 ± 0.10	0.50 nom.	0.40 ± 0.10	0.30 ± 0.10	0.40 ± 0.10	0.20 ± 0.10	0.25 ± 0.10
NRSNØ4I4	1.00 ± 0.20	2.00 ± 0.10	0.50 nom.	0.40 ± 0.10	0.30 ± 0.10	-	0.15 ± 0.10	0.25 ± 0.10
NRSNA6I4	1.60 ± 0.15	3.20 ± 0.20	0.80 nom.	0.50 ± 0.10	0.45 ± 0.10	0.60 ± 0.10	0.30 ± 0.15	0.30 ± 0.15
NRSNØ6I4	1.60 ± 0.15	3.20 ± 0.20	0.80 nom.	0.55 ± 0.10	0.50 ± 0.10	-	0.35 ± 0.15	0.45 ± 0.15
NRSNØ6C8	3.10 ± 0.20	6.40 ± 0.20	1.27 ± 0.20	0.60 ± 0.20	1.00 ± 0.20	-	0.55 ± 0.20	0.50 ± 0.20
NRSNØ6D8	3.10 ± 0.20	6.40 ± 0.20	1.27 ± 0.20	0.60 ± 0.20	1.00 ± 0.20	-	0.55 ± 0.20	0.50 ± 0.20
NRSN12I4	3.00 ± 0.20	5.08 ± 0.20	1.27 ± 0.20	0.70 ± 0.20	0.80 ± 0.20	-	0.60 ± 0.20	0.60 ± 0.20

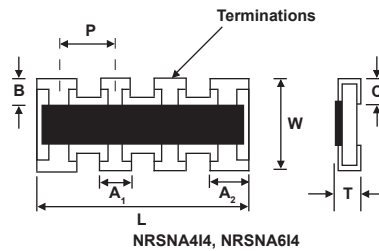
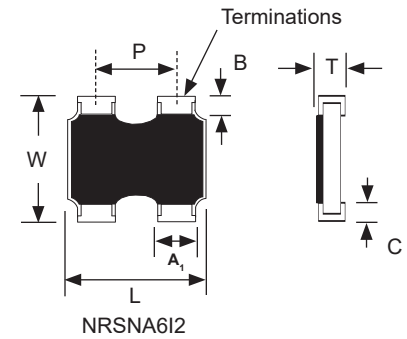
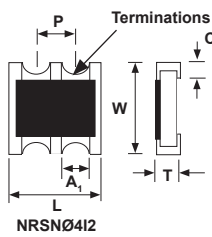
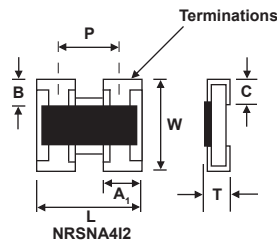

Marked
E-24 2% & 5%
E-96 1%

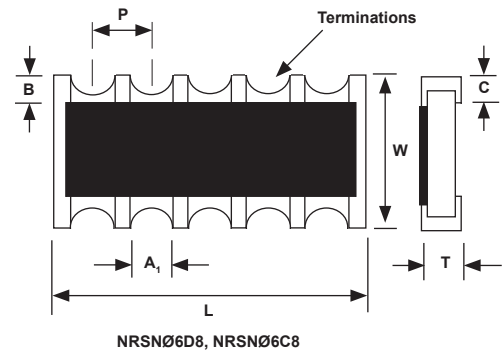
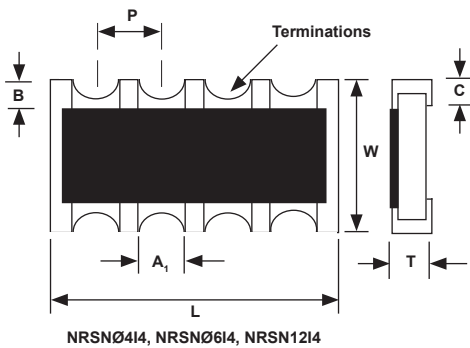

Terminations (all sizes):
100% Sn finish over Ni Barrier

LAND PATTERN DIMENSIONS (mm)

Type	Reflow Soldering					Flow Soldering			
	A	B	P	S	F	A	B	P	F
NRSNØ4I2	0.50	0.28	0.50	0.34	2.00	-	-	-	-
NRSNA4I2	0.50	0.33	0.67	0.34	2.00	-	-	-	-
NRSNA6I2	0.80	0.45	0.80	0.35	2.40	-	-	-	-
NRSNØ4I4	0.50	0.28	0.50	0.22	2.00	-	-	-	-
NRSNA4I4	0.50	0.28	0.50	0.22	2.00	-	-	-	-
NRSNØ6I4J	1.00	0.40	0.80	0.40	2.60	0.7 ~ 0.9	0.3 ~ 0.35	0.8	4.6 ~ 5.6
NRSNA6I4J	1.00	0.40	0.80	0.40	2.60	0.7 ~ 0.9	0.3 ~ 0.35	0.8	4.6 ~ 5.6
NRSNØ6C8	2.20	0.50	1.27	-	4.20	1.9 ~ 2.1	0.5 ~ 0.55	1.27	5.6 ~ 6.2
NRSNØ6D8	2.20	0.50	1.27	-	4.20	1.9 ~ 2.1	0.5 ~ 0.55	1.27	5.6 ~ 6.2
NRSN12I4	2.20	0.790	1.27	-	4.20	1.0 ~ 1.2	0.4 ~ 0.45	1.27	5.6 ~ 6.2

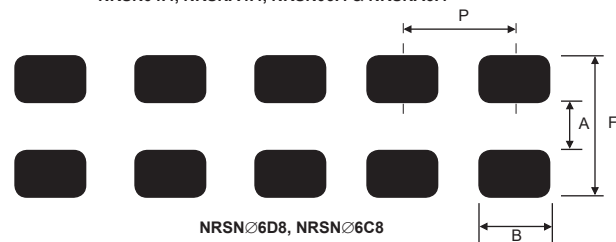
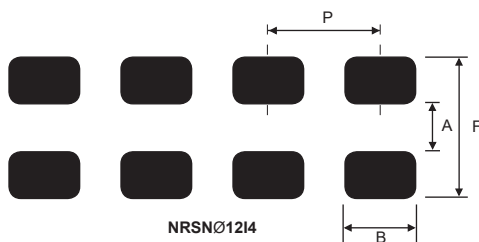
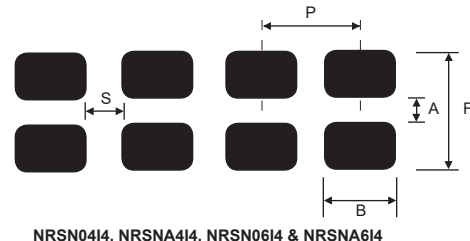
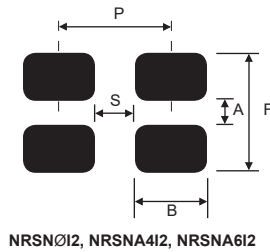

Reflow Soldering Heat Profile and Limits
 → www.niccomp.com/resource/files/resistive/NIC-ChipR-Reflow-Sept2020-Rev2.pdf
 Wave soldering? – Please review your wave soldering process profile with NIC: tpmg@niccomp.com

TAPE DIMENSIONS (mm)

Type	Material	A	B	F	p1	W	t ₁	t ₂
NRSNØ4I2	Paper	1.20 ± 0.1	1.207 ± 0.1	3.5 ± 0.05	2.0 ± 0.1	8.0 ± 0.2	0.5 max.	1.0 max.
NRSNA4I2			2.20 ± 0.1					
NRSNØ4I4		1.80 ± 0.2	1.8 ± 0.2		0.64 max.		0.94 max.	
NRSNA4I4		1.90 ± 0.1	3.45 ± 0.1					
NRSNØ6I4	Plastic	3.5 ± 0.1	6.75 ± 0.1	5.5 ± 0.05	4.0 ± 0.1	12.0 ± 0.2	1.0 max.	1.4 max.
NRSNA6I4			5.7 ± 0.1					
NRSNØ6C8								
NRSNØ6D8								
NRSN12I4								

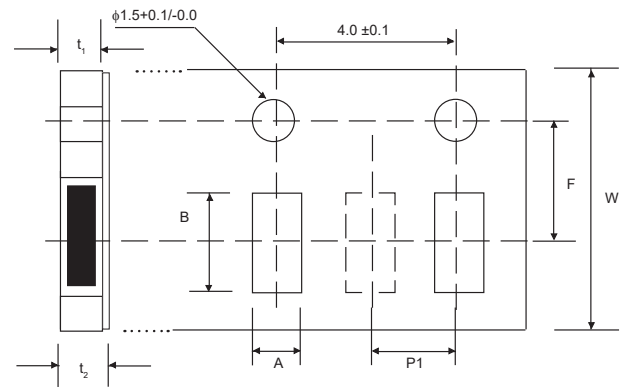

REEL DIMENSIONS (mm)

Type	A	B	C	D	E	W	Qty/Reel
NRSN04I2 NRSNA4I2 NRSN04I4 NRSNA4I4						8.0 ±0.2	10,000
NRSNA6I2	φ180 -4.0/+3.0	φ60 -4.0/+3.0	φ13.0 ±2.0	φ21.0 ±1.0	2.0 ±0.5	9.0 ±1.0	5,000
NRSN06I4 NRSNA6I4						10 ±1.0	5,000
NRSN06C8 NRSN06D8 NRSN12I4						14 ±2.0	4,000

