

Anti-Surge Thick Film Chip Resistors

NRCPS Series

FEATURES

- EXCELLENT ANTI-SURGE & ANTI-SULFUR CHARACTERISTICS
- AEC-Q200 QUALIFIED
- RATED POWER UPGRADE IN SMALLER PACKAGE SIZE
- AVAILABLE IN $\pm 0.5\%$ (D) TOLERANCE
- BOTH FLOW SOLDER AND REFLOW SOLDERING ARE APPLICABLE

RoHS Compliant
includes all homogeneous materials

*See Part Number System for Details



SPECIFICATIONS

Type	EIA Size	Power Rating at 70°C	Max. *1 Working Voltage	Max. *2 Overload Voltage	Resistance Tolerance Code	Temperature Coefficient (ppm/°C)	Resistance Range (Ω)	Resistance Value	Operating Temperature Range
NRCPS06	0603	1/4W (0.25W)	150	200	0.5% (D)	±200ppm	1.0 ~ 9.76	E-24, E-96	-55°C ~ +155°C
						±100ppm	10 ~ 1M		
					1% (F)	±200ppm	1.0 ~ 9.76	E-24, E-96	
						±100ppm	10 ~ 1M		
					5% (J)	±200ppm	1.0 ~ 9.1	E-24	
						±100ppm	10 ~ 1M		
NRCPS10	0805	1/3W (0.33W)	200	400	0.5% (D)	±200ppm	1.0 ~ 9.76	E-24, E-96	
						±100ppm	10 ~ 1M		
					1% (F)	±200ppm	1.0 ~ 9.76	E-24, E-96	
						±100ppm	10 ~ 1M		
					5% (J)	±200ppm	1.0 ~ 9.1	E-24	
						±100ppm	10 ~ 1M		
NRCPS12	1206	1/2W (0.50W)	200	400	0.5% (D)	±200ppm	1.0 ~ 9.76	E-24, E-96	
						±100ppm	10 ~ 1M		
					1% (F)	±200ppm	1.0 ~ 9.76	E-24, E-96	
						±100ppm	10 ~ 1M		
					5% (J)	±200ppm	1.0 ~ 9.1	E-24	
						±100ppm	10 ~ 1M		
NRCPS25	1210	3/4W (0.75W)	200	400	0.5% (D)	±200ppm	1.0 ~ 9.76	E-24, E-96	
						±100ppm	10 ~ 1M		
					1% (F)	±200ppm	1.0 ~ 9.76	E-24, E-96	
						±100ppm	10 ~ 1M		
					5% (J)	±200ppm	1.0 ~ 9.1	E-24	
						±100ppm	10 ~ 1M		

Note *1 - Maximum allowable continuous Working Voltage for all resistors is the lower of the two values: "Maximum Working Voltage" as specified above (or)

$$\sqrt{\text{Power rating (Watts)} \times \text{Resistance (Ohms)}}$$

Note *2 - Maximum allowable Overload voltage is 2.5 times the Maximum Working Voltage (see Note *1 above) or Maximum Overload Voltage as specified in the table whichever is lower

Power Derating Curve: For operation above 70°C, power rating must be derated according to the following chart:

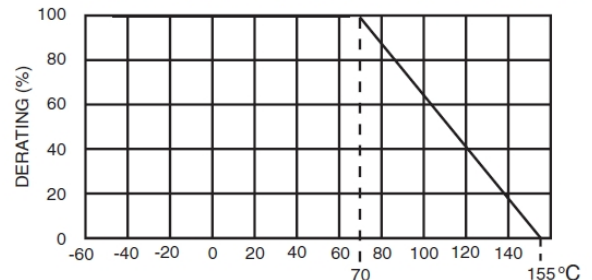

PART NUMBER SYSTEM (E-24 VALUES)

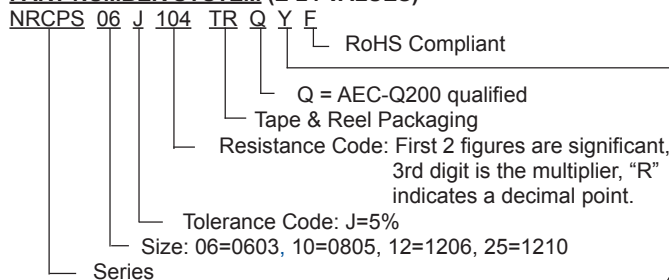

PART NUMBER SYSTEM (E-96 VALUES)

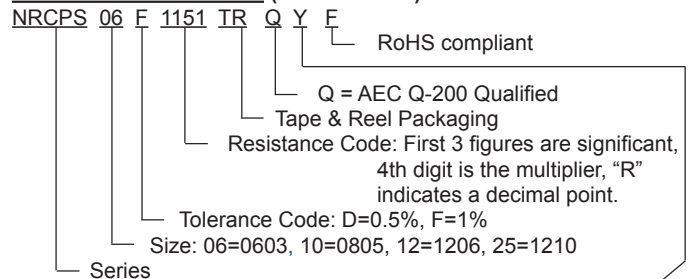

"Y" denotes suitable for automotive equipment, sourced to special production and inspection at TS-16949 certified production site

"Y" denotes suitable for automotive equipment, sourced to special production and inspection at TS-16949 certified production site



COMPONENT DIMENSIONS (mm)

Type	EIA Size	L	W	H	P1	P2
NRCPS06	0603	1.60 ± 0.10	0.80 +0.15/-0.05	0.45 ± 0.10	0.30 ± 0.10	0.25 ± 0.10
NRCPS10	0805	2.00 ± 0.10	1.25 ± 0.10	0.55 ± 0.10	0.40 ± 0.20	0.30 ± 0.20
NRCPS12	1206	3.10 ± 0.10	1.60 ± 0.15	0.55 ± 0.10	0.50 ± 0.25	0.40 ± 0.25
NRCPS25	1210	3.10 ± 0.15	2.50 ± 0.15	0.55 ± 0.10	0.50 ± 0.25	0.40 ± 0.25

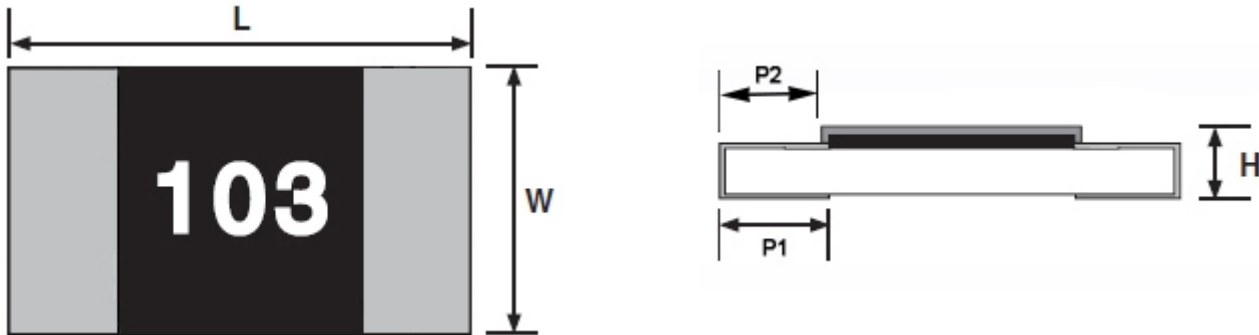

E-24 AND E-96 STANDARD VALUES

E-24	E-96			
100	100	102	105	107
110	110	113	115	118
120	121	124	127	130
130	133	137	140	143
150	147	150	154	158
160	162	165	169	174
180	178	182	187	191
200	196	200	205	210
220	215	221	226	232
240	237	243	249	255
270	261	267	274	280
300	287	294	301	309
330	316	324	332	340
360	348	357	365	374
390	383	392	402	412
430	422	432	442	453
470	464	475	487	499
510	511	523	536	549
560	562	576	590	604
620	619	634	649	665
680	681	698	715	732
750	750	768	787	806
820	825	845	866	887
910	909	931	953	976

COMPONENT MARKING EXAMPLES (0805, 1206 & 1210 Sizes)

No Marking on 0603 Size E-96 Values

1% AND 5% TOLERANCE E-24 VALUES

Value: 10K Ω

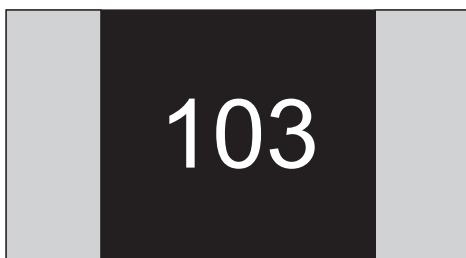

0603, 0805, 1206 & 1210 Sizes

0.5% & 1% TOLERANCE E-96 VALUES

Value: 562K Ω

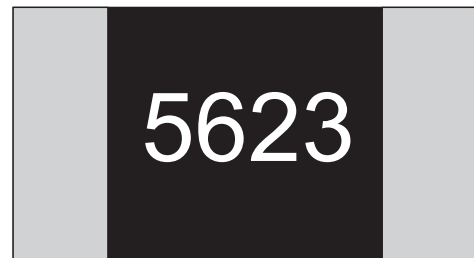

0805, 1206 & 1210 Sizes



CONSTRUCTION

No.	Item	Main Material
1	Substrate	Alumina
2	Resistor	Thick Film RuO ₂
3	Protective Coating	Glass
4	Protective Coating	Resin
5	Bottom Terminal	Thick Film Ag
6	Upper Terminal 1	Thick Film Ag-Pd
7	Upper Terminal 2	Thick Film Ag
8	Side Terminal	Thin Film NiCr
9	Terminal Plating	1st (Ni)
10	Terminal Plating	2nd (100% Sn)

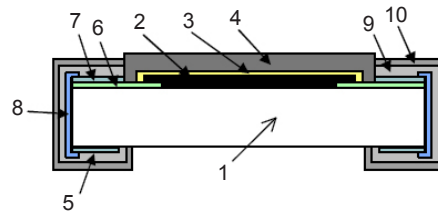

Test Conditions:
H₂S: 10ppm, 60°C, 90% RH

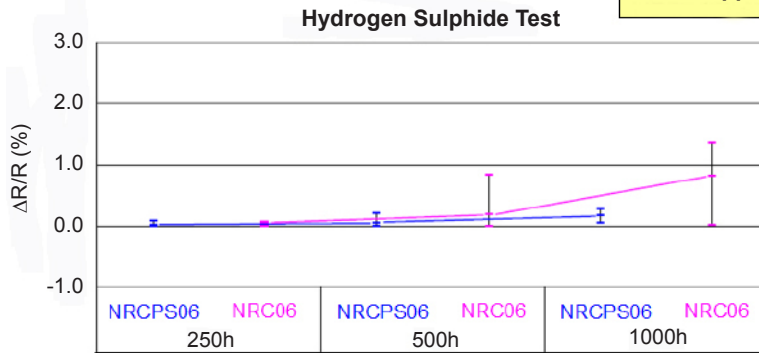

Single Pulse Power Characteristics NRCPS vs. NRC Series

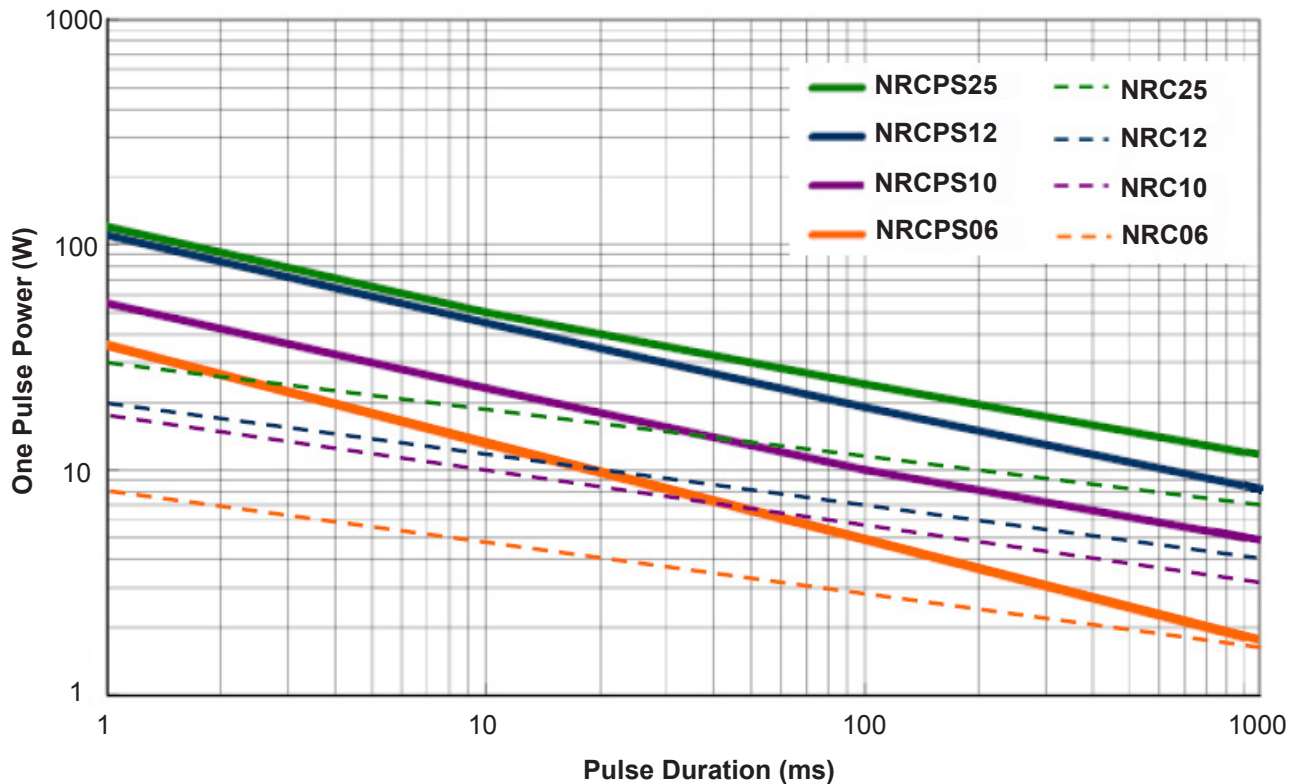

PERFORMANCE CHARACTERISTICS

Test Items	Requirement $\Delta R = \pm ([] + 0.05\Omega)$	Test Method (AEC-Q200 REV. D)
High temperature exposure (storage) AEC-Q200 - No. 3	[1.0%]	155°C 1,000 hours (no load)
Temperature Cycling AEC-Q200 - No. 4	[0.5%]	100 times at -55°C 30 minutes/+125°C 30 minutes
Humidity Load Life AEC-Q200 - No. 7	[1%]	+85°C, 85% RH @ 10% of rated power applied continuously for 1,000 hours
Load Life AEC-Q200 - No. 8	[1%]	Voltage to achieve 35% of rated power or 150V whichever is less applied continuously for 1,000 hours @ 125°C
Physical Dimensions AEC-Q200 - No. 10	JESD22 Method JB-100	As in table "DIMENSIONS (mm)" on page 2
Resistance to solvents AEC-Q200 - No. 12	No visible damage to marking and coating	Solvent: 2-propanol @ 25°C 3 cycles of immersion for 3 minutes & brushed 10 times
Mechanical Shock AEC-Q200 - No. 13	[0.5%]	Waveform: alf sine, peak value 100G Normal duration 6ms, Condition: X, Y, Z 10 times in each direction
Vibration AEC-Q200 - No. 14	[0.5%]	Peak acceleration: 5g's for 20 minutes Frequency: 10Hz ~ 2,000Hz 12 cycles in each of 3 orientations
Resistance to Soldering Heat AEC-Q200 - No. 15	[0.5%]	Immersion into solder bath at 260°C for 10 seconds
ESD AEC-Q200 - No. 17	[1.0%]	Human Body Model, 2K ohm resistor, 150pF capacitor Test voltage: 0603 - 2KV, 0805, 1206 & 1210 - 3KV
Solderability AEC-Q200 - No. 18	Terminal surface shall be immersed, minimum of 95% coverage with new solder	J-STD-002 a) Method B, 4 hours @ +155°C dry heat. @+235°C for 5 secs. Sn96.5-Ag3-Cu0.5 b) Method B @ +215°C for 5 secs, category 3, Sn63Pb37 c) Method D, category 3 @ +260°C for 7 secs.
PCB Flexing AEC-Q200 - No. 21	[0.5%]	AEC-Q200-005 Bending to 2mm for 60 seconds
Adhesion AEC-Q200 - No. 22	[0.5%]	AEC-Q200-006 Pressurized force: 0603 - 10N, 0805, 1206 & 1210 - 17.7N Duration: 60 secs \pm 1 sec.

CLIMATE CATEGORY (IEC 60068): 55/155/56

Lower category temperature: -55°C

Upper category temperature: +155°C

Duration of damp heat, steady state: 56 days

REFLOW SOLDERING TEMPERATURE PROFILE

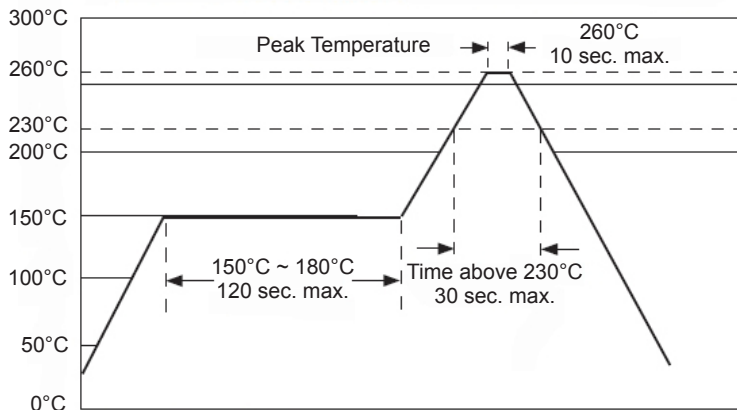

Note: Maximum of 2 times

RECOMMENDED FLOW SOLDERING CONDITIONS

Pb-free Solder: Sn3.0 - Ag0.5 - Cu

Preheat: 110°C ~ 130°C for 60 ~ 120 seconds

Peak Temperature: 245°C ~ 250°C for 3 ~ 5 seconds

LAND PATTERN DIMENSIONS (mm)

Size	Type	a	b	c
0603	Flow	1.0	0.5	0.8
	Reflow	1.0	0.8	0.8
0805	Flow	1.3	0.7	1.25
	Reflow	1.3	0.9	1.25
1206	Flow	2.2	0.85	1.6
	Reflow	2.2	1.05	1.6
1210	Flow	2.2	0.85	2.5
	Reflow	2.2	1.05	2.5

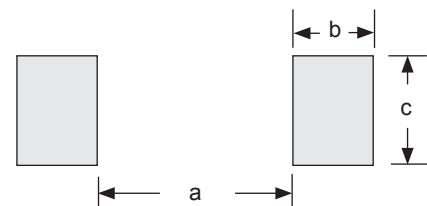

PAPER CARRIER TAPE DIMENSIONS (mm)

Type	EIA Size	A	B	D	E	F	P ₀	P ₁	T	W
NRCPS06	0603	1.15 ± 0.15	1.90 ± 0.20	1.5 +0.1/-0	1.75 ± 0.1	3.5 ± 0.05	4.0 ± 0.1	4.0 ± 0.1	0.80 max.	8.0 ± 0.2
NRCPS10	0805	1.65 ± 0.15	2.50 ± 0.20						1.00 max	
NRCPS12	1206	2.00 ± 0.15	3.60 ± 0.20							

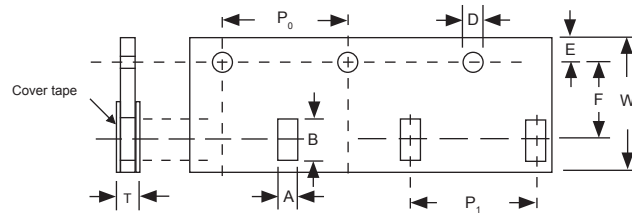

PLASTIC CARRIER TAPE DIMENSIONS (mm)

Type	EIA Size	A	B	D	E	F	P ₀	P ₁	T1	T2	W
NRCPS25	1210	2.85 ± 0.20	3.50 ± 0.20	1.5 +0.1/-0	1.75 ± 0.10	3.5 ± 0.05	4.0 ± 0.1	4.0 ± 0.1	0.3 max.	1.00 ± 0.20	8.0 ± 0.3

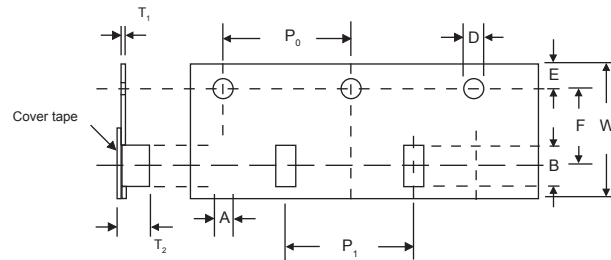

REEL DIMENSIONS AND QUANTITY

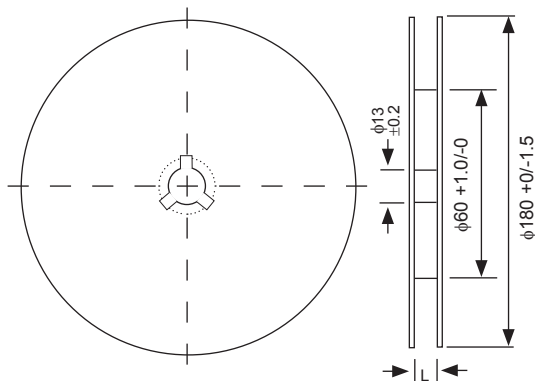

Type	EIA Size	L	Quantity
NRCPS06	0603	9.0 +1.0/0	5,000
NRCPS10	0805		5,000
NRCPS12	1206		5,000
NRCPS25	1210		4,000