

REDUCED SIZE, LOW IMPEDANCE, RADIAL LEADS, POLARIZED
ALUMINUM ELECTROLYTIC CAPACITORS

FEATURES

- FURTHER REDUCED SIZING
- LOW IMPEDANCE AT HIGH FREQUENCY
- IDEALLY FOR SWITCHERS AND CONVERTERS

RoHS Compliant
includes all homogeneous materials

*See Part Number System for Details

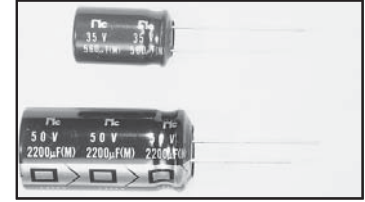

CHARACTERISTICS

Rated Voltage Range	6.3 ~ 50Vdc						
Capacitance Range	1.0 ~ 15,000µF						
Operating Temperature Range	-55 ~ +105°C						
Capacitance Tolerance	±20%(M)						
Max. Leakage Current After 2 minutes At +20°C	0.01CV or 3µA, whichever is greater						
Max. Tan δ @ 120Hz/+20°C	W.V. (Vdc)	6.3	10	16	25	35	50
	S.V. (Vdc)	8	13	20	32	44	63
	C ≤ 1,000µF	0.28	0.24	0.20	0.16	0.14	0.12
	C = 2,200µF	0.30	0.26	0.22	0.18	0.16	0.14
	C = 3,300µF	0.32	0.28	0.24	0.20	0.18	-
	C = 4,700µF	0.34	0.30	0.26	0.22	-	-
	C = 6,800µF	0.38	0.34	0.30	-	-	-
	C = 10,000µF	0.56	0.42	-	-	-	-
Low Temperature Stability Impedance Ratio @ 120Hz	Z-40°C/Z+20°C	3	3	2	2	2	2
	Z-55°C/Z+20°C	6	5	4	4	3	3
Load Life Test at Rated W.V. +105°C 1,000 Hours = 8φ or less +105°C 2,000 Hours = 10φ +105°C 3,000 Hours = 12.5φ up	Capacitance Change	Within ±25% of initial measured value					
	Tan δ	Less than 200% of specified maximum value					
	Leakage Current	Less than specified maximum value					

STANDARD PRODUCT AND CASE SIZE TABLE D φ x L (mm)

Cap. (µF)	Code	Working Voltage (Vdc)					
		6.3	10	16	25	35	50
1.0	1R0	-	-	-	-	-	5x11
2.2	2R2	-	-	-	-	-	5x11
3.3	3R3	-	-	-	-	-	5x11
4.7	4R7	-	-	-	-	-	5x11
10	100	-	-	-	-	-	5x11
22	220	-	-	-	-	-	5x11
33	330	-	-	-	-	5x11	5x11
47	470	-	-	-	-	5x11	6.3x11
100	101	-	-	5x11	6.3x11	6.3x11	8x11.5
220	221	5x11	6.3x11	6.3x11	8x11.5	8x11.5	10x12.5
330	331	6.3x11	6.3x11	8x11.5	8x11.5	10x12.5	10x16
470	471	6.3x11	8x11.5	8x11.5	10x12.5	10x16	10x20
1000	102	8x11.5	10x12.5	10x16	10x20	12.5x20	12.5x25
2200	222	10x16	10x20	12.5x20	12.5x25	16x25	16x31.5
3300	332	10x20	12.5x20	12.5x25	16x25	16x35.5	-
4700	472	12.5x20	12.5x25	16x25	16x31.5	-	-
6800	682	12.5x25	16x25	16x31.5	-	-	-
10000	103	16x25	16x31.5	-	-	-	-
15000	153	16x35.5	-	-	-	-	-

LEADSPACE AND DIAMETER (mm)

Case Dia. (Dφ)	5	6.3	8	10	12.5	16
Lead Dia. (dφ)	0.5	0.5	0.6	0.6	0.6	0.8
Lead Spacing (F)	2.0	2.5	3.5	5.0	5.0	7.5
Dim. α	0.5	0.5	0.5	0.5	0.5	0.5

$\beta = L < 20\text{mm} = 1.5\text{mm}, L \geq 20\text{mm} = 2.0\text{mm}$

DIMENSIONS (mm)

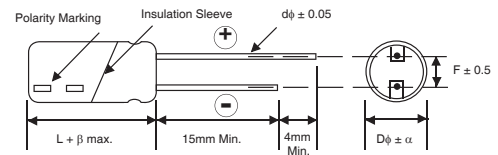

Drawing is representative of parts as supplied in bulk or straight lead format, please see taping specification for details on taped format packaging.

STANDARD PRODUCT, SPECIFICATIONS AND CASE SIZES D φ x L (mm)

Part Number	Cap. (μF)	W.V. (Vdc)	Max. Tanδ	Max. LC (μA)	Max. Impedance	Max. Ripple Current at 10KHz~200KHz/105°C (mA rms)	Load Life Hours @ +105°C	
					100KHz/20°C			
NRSY221M6.3V5x11F	220	6.3	0.28	13.86	0.50	180	1000	
NRSY331M6.3V6.3x11F	330		0.28	20.79	0.30	280	1000	
NRSY471M6.3V6.3x11F	470		0.28	29.61	0.24	280	1000	
NRSY102M6.3V8x11.5F	1000		0.28	63	0.15	560	1000	
NRSY222M6.3V10x16F	2200		0.30	138.6	0.066	950	2000	
NRSY332M6.3V10x20F	3300		0.32	207.9	0.047	1150	2000	
NRSY472M6.3V12.5x20F	4700		0.34	296.1	0.042	1460	3000	
NRSY682M6.3V12.5x25F	6800		0.38	428.4	0.031	1780	3000	
NRSY103M6.3V16x25F	10000		0.56	630	0.026	2000	3000	
NRSY153M6.3V16x35.5F	15000		0.56	945	0.022	2200	3000	
NRSY221M10V6.3x11F	220	10	0.24	22	0.30	280	1000	
NRSY331M10V6.3x11F	330		0.24	33	0.24	280	1000	
NRSY471M10V8x11.5F	470		0.24	47	0.16	410	1000	
NRSY102M10V10x12.5F	1000		0.24	100	0.086	710	2000	
NRSY222M10V10x20F	2200		0.26	220	0.047	1150	2000	
NRSY332M10V12.5x20F	3300		0.28	330	0.042	1460	3000	
NRSY472M10V12.5x25F	4700		0.30	470	0.031	1780	3000	
NRSY682M10V16x25F	6800		0.34	680	0.026	2000	3000	
NRSY103M10V16x31.5F	10000		0.42	1000	0.022	2200	3000	
NRSY101M16V5x11F	100		16	0.20	16	0.50	180	1000
NRSY221M16V6.3x11F	220	0.20		35.2	0.24	280	1000	
NRSY331M16V8x11.5F	330	0.20		52.8	0.16	410	1000	
NRSY471M16V8x11.5F	470	0.20		75.2	0.15	560	1000	
NRSY102M16V10x16F	1000	0.20		160	0.06	950	2000	
NRSY222M16V12.5x20F	2200	0.22		352	0.042	1460	3000	
NRSY332M16V12.5x25F	3300	0.24		528	0.040	1650	3000	
NRSY472M16V16x25F	4700	0.26		752	0.026	2000	3000	
NRSY682M16V16x31.5F	6800	0.30		1088	0.022	2200	3000	
NRSY101M25V6.3x11F	100	25		0.16	25	0.30	280	1000
NRSY221M25V8x11.5F	220		0.16	55	0.16	410	1000	
NRSY331M25V8x11.5F	330		0.16	82.5	0.15	510	1000	
NRSY471M25V10x12.5F	470		0.16	117.5	0.086	710	2000	
NRSY102M25V10x20F	1000		0.16	250	0.047	1150	2000	
NRSY222M25V12.5x25F	2200		0.18	550	0.040	1650	3000	
NRSY332M25V16x25F	3300		0.20	825	0.026	2000	3000	
NRSY472M25V16x31.5F	4700		0.22	1175	0.022	2200	3000	
NRSY330M35V5x11F	33		35	0.14	11.55	0.72	180	1000
NRSY470M35V5x11F	47			0.14	16.45	0.50	180	1000
NRSY101M35V6.3x11F	100	0.14		35	0.24	280	1000	
NRSY221M35V8x11.5F	220	0.14		77	0.15	560	1000	
NRSY331M35V10x12.5F	330	0.14		115.5	0.086	710	2000	
NRSY471M35V10x16F	470	0.14		164.5	0.066	950	2000	
NRSY102M35V12.5x20F	1000	0.14		350	0.042	1460	3000	
NRSY222M35V16x25F	2200	0.16		770	0.026	2000	3000	
NRSY332M35V16x35.5F	3300	0.18		1155	0.022	2200	3000	

For Automotive Applications see part number system

PART NUMBER SYSTEM

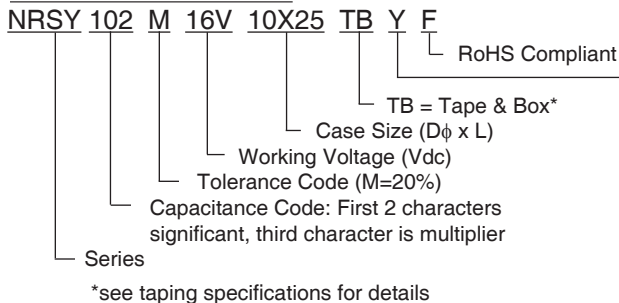

Optional: For automotive equipment, sourced to special production and inspection at TS-16949 certified production site;



Part Number	Cap. (μF)	W.V. (Vdc)	Max. Tanδ	Max. LC (μA)	Max. Impedance	Max. Ripple Current at 10KHz~200KHz/105°C (mA rms)	Load Life Hours @ +105°C
					100KHz/20°C		
NRSY1R0M50V5x11F	1.0	50	0.12	3.0	3.30	30	1000
NRSY2R2M50V5x11F	2.2		0.12	3.0	3.00	45	1000
NRSY3R3M50V5x11F	3.3		0.12	3.0	2.70	55	1000
NRSY4R7M50V5x11F	4.7		0.12	3.0	2.00	90	1000
NRSY100M50V5x11F	10		0.12	5.0	1.70	110	1000
NRSY220M50V5x11F	22		0.12	11	1.20	120	1000
NRSY330M50V5x11F	33		0.12	16.5	0.95	130	1000
NRSY470M50V6.3x11F	47		0.12	23.5	0.56	190	1000
NRSY101M50V8x11.5F	100		0.12	50	0.30	320	1000
NRSY221M50V10x12.5F	220		0.12	110	0.16	520	2000
NRSY331M50V10x16F	330		0.12	165	0.12	670	2000
NRSY471M50V10x20F	470		0.12	235	0.088	820	2000
NRSY102M50V12.5x25F	1000		0.12	500	0.053	1200	3000
NRSY222M50V16x31.5F	2200		0.14	1100	0.029	1750	3000

For Automotive Applications see part number system

RIPPLE CURRENT CORRECTION FACTOR

Frequency (Hz)	100 < f < 1K	1K < f < 10K	10K < f
22 < C < 100	0.55	0.8	1.0
100 < C < 1000	0.7	0.9	1.0
1000 < C	0.9	0.95	1.0

PRECAUTIONS

Please review the notes on correct use, safety and precautions found on pages T10 & T11 of NIC's Electrolytic Capacitor catalog.
 Also found at www.niccomp.com/precautions
 If in doubt or uncertainty, please review your specific application - process details with NIC's technical support personnel: tpmg@niccomp.com



Miniature Aluminum Electrolytic Capacitors Taping Specifications

STANDARD RADIAL TAPING (5mm LEAD SPACING, FORMED LEADS) TB

Taping Dimensions (mm)

Case Dia. (D ϕ)	4	5	6.3	8
Case Size	4x5 4x7	5x5 5x7	5x11	6.3x5 6.3x7 6.3x11 8x11.5
d ϕ \pm 0.05	0.45	0.45	0.5	0.45
H \pm 0.75	17.5	17.5	18.5	17.5
F +0.8 ~ -0.2	5.0 -0.2 ~ +0.8			
P	12.7 \pm 1.0			
P ₀	12.7 \pm 0.2			
P ₁	3.85 \pm 0.5 (at end of tape)			
P ₂	6.35 \pm 1.0			
W	18.0 \pm 0.5			
W ₀	11.5 min.			
W ₁	9.0 \pm 0.5			
W ₂	0 ~ 2.5			
H ₀	16.0 \pm 0.5			
l	1.0 max.			
D ₀ ϕ	4.0 \pm 0.2			
Δ h	0 \pm 1.0 (at top of can)			
t	0.7 \pm 0.2 (not including lead)			

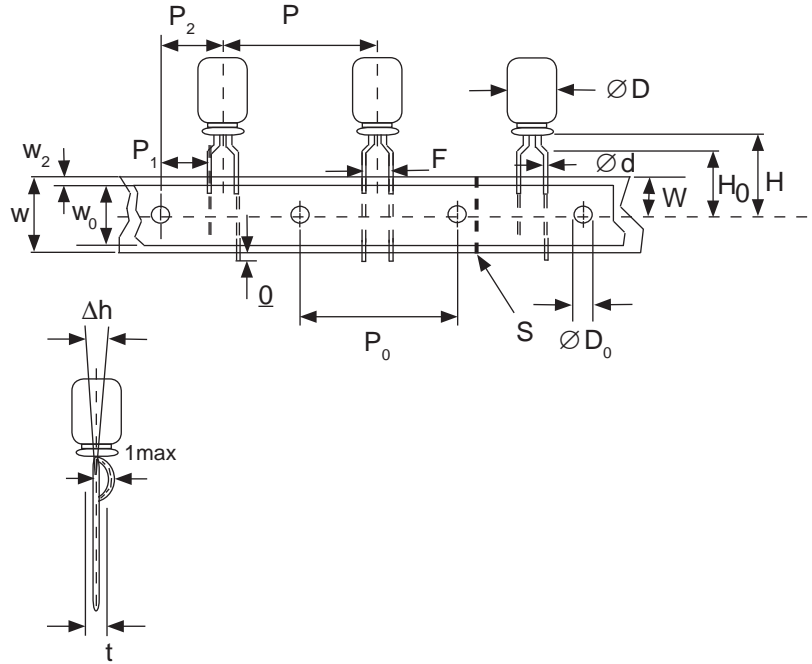

STANDARD RADIAL TAPING (5mm LEAD SPACING, STRAIGHT LEADS) TB

Taping Dimensions (mm)

Case Dia. (D ϕ)	10	12.5
Case Size	All	All
d ϕ \pm 0.05	0.6	0.6
H \pm 0.75	19.0	19.0
F +0.8 ~ -0.2	5.0	5.0
P \pm 1.0	25.4*	
P ₀	12.7 \pm 0.2	
P ₁	3.85	
P ₂	6.35 \pm 1.0	
W	18.0 \pm 0.5	
W ₀	11.5 min	
W ₁	9.0 \pm 0.5	
W ₂	0 ~ 2.5	
H ₀	16.0 \pm 0.5	
l	1.0 max.	
D ₀ ϕ	4.0 \pm 0.2	
Δ h	0 \pm 1.0 (at top of can)	
t	0.7 \pm 0.2 (not including lead)	

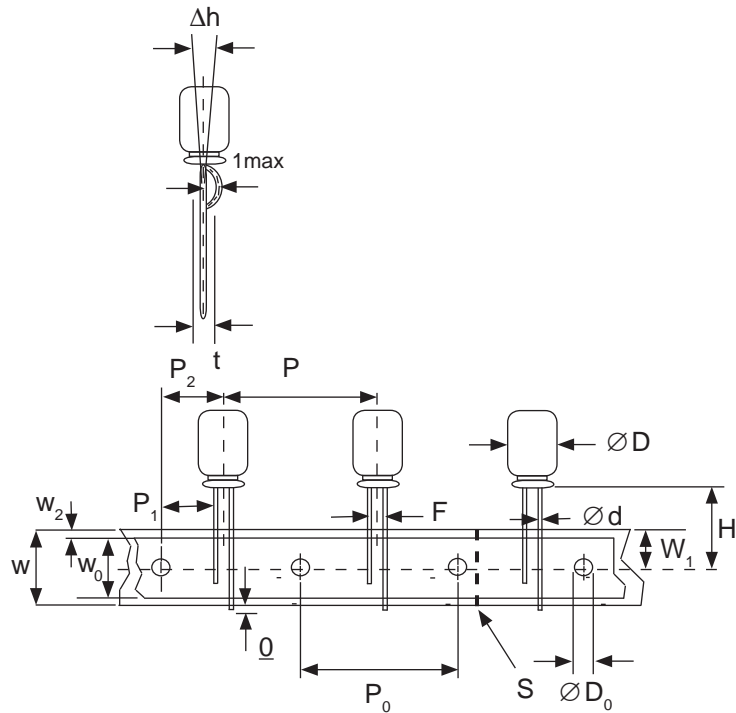

*Optional Taping Specifications

10mm diameter available with P dim. = 12.7mm
(P/N Suffix: TB12.7MMP)

12.5mm diameter available with P dim. = 15mm, P₁ = 5.0mm,
P₀ = 15.0mm & P₂ = 7.5mm (P/N Suffix: TB15MMP)

NOTE: ANODE (+) LEAD FEEDS OFF FIRST.
FOR OPTION OF NEGATIVE (-) LEAD FIRST,
SPECIFY "TBN".



Miniature Aluminum Electrolytic Capacitors Taping Specifications

SPECIAL RADIAL TAPING (2.5mm LEAD SPACING, FORMED LEADS) TBF1

Taping Dimensions (mm)

Case Dia. (D ϕ)	4		5	
Case Size Dim.	4x5 4x7	5x5 5x7	5x11	
d ϕ \pm 0.05	0.45	0.45	0.5	
H \pm 0.75	17.5	17.5	18.5	
H ₀ \pm 0.5	16.0	-	-	
F	2.5 -0.2 ~ +0.8			
P	12.7 \pm 1.0			
P ₀	12.7 \pm 0.2			
P ₁	5.1 \pm 0.5			
P ₂	6.35 \pm 1.0			
W	18.0 \pm 0.5			
W ₀	11.5 min.			
W ₁	9.0 \pm 0.5			
W ₂	0 ~ 1.5			
l	1.0 max.			
D ₀ ϕ	4.0 \pm 0.2			
Δ h	0 \pm 1.0			
t	0.7 \pm 0.2			

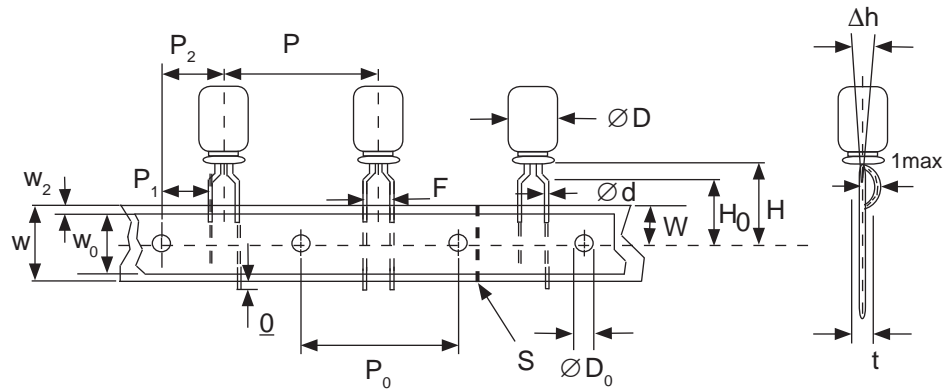

SPECIAL STRAIGHT LEAD TAPING TBST

Taping Dimensions (mm)

Case Dia. (D ϕ)	4			5			6.3		8	
Case Size Dim.	4x5 4x7	5x5 5x7	5x11		6.3x5 6.3x7	6.3x11		8x11.5		
d ϕ \pm 0.05	0.45	0.45	0.5		0.45	0.5		0.6		
H \pm 0.75	17.5	17.5	18.5		17.5	18.5		20.0		
F +0.8 ~ -0.2	2.0*	2.0	2.0		2.5	2.5		3.5		
P \pm 1.0	12.7 \pm 0.2									
P ₀	12.7 \pm 0.2									
P ₁	5.1	5.1	5.1	5.1	5.1	5.1	4.6			
P ₂	6.35 \pm 1.0									
W	18.0 \pm 0.5									
W ₀	11.5 min.									
W ₁	9.0 \pm 0.5									
W ₂	0 ~ 2.5									
H ₀	16.0 \pm 0.5									
l	1.0 max.									
D ₀ ϕ	4.0 \pm 0.2									
Δ h	0 \pm 1.0 (at top of can)									
t	0.7 \pm 0.2 (not including lead)									

* Parts with 4mm diameter are taped with a slight flare in the lead and a 2.0mm lead-space.

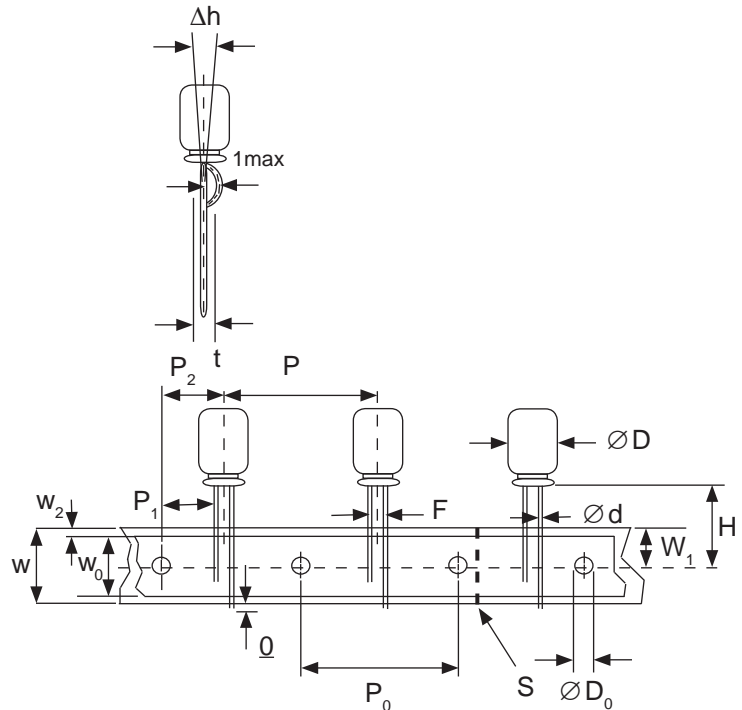

RADIAL TAPED PACKAGING

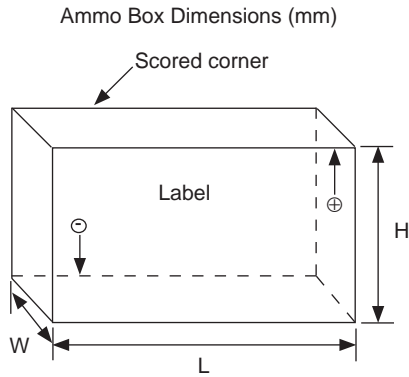

Ammo Box (Tape & Box) TB, TBF1, TBST

Size of box and component quantity

Case Dia (D ϕ) or Case Size	Q'ty per Box (pcs)	Dim. L	Dim. H	Dim. W
4x5, 4x7	2,000	331	175	43
5x5, 5x7	2,000	331	220	43
5x11	2,000	340	255	55
6.3x5, 6.3x7	2,000	331	280	43
6.3x11	2,000	331	280	48
8x11.5, 8x12.5	1,000	335	235	53
10x12.5*	500	335	190	53
10x16*	500	335	300	53
10x20*	500	335	300	55
12.x20*	500	335	300	55
12.5x25*	500	335	300	61

*Special Taping Consult Factory For Availability