

## FEATURES

- SHIELDED POWER INDUCTOR
- HIGH CURRENT (UP TO 12 AMPS)
- SURFACE MOUNTABLE CONSTRUCTION
- HIGH INDUCTANCE (UP TO 1000 $\mu$ H)
- TAPED AND REELED FOR AUTOMATIC INSERTION
- FOR USE IN DC/DC CONVERTERS

**RoHS  
Compliant**  
includes all homogeneous materials

\*See Part Number System for Details



## CHARACTERISTICS

Case Size	NPIS62H	NPIS64H	NPIS73H	NPIS74H	NPIS14H
Inductance Range	3.3 ~ 330 $\mu$ H	10 ~ 1,000 $\mu$ H	10 ~ 1,000 $\mu$ H	10 ~ 1,000 $\mu$ H	4.7 ~ 470 $\mu$ H
Ambient Operating Temperature Range	-40°C ~ +125°C (including temperature rise)				
Temperature Rise at Irms	+40°C max.				
Inductance Change at Isat	-25% typical				
Inductance Tolerance	20% (M)				
Resistance to Solder Heat	260°C for 10 seconds				

Case Size	NPIS24H	NPIS25H	NPIS27H
Inductance Range	1.0 ~ 330 $\mu$ H	1.0 ~ 1,000 $\mu$ H	1.0 ~ 1,000 $\mu$ H
Ambient Operating Temperature Range	-40°C ~ +125°C (including temperature rise)		
Temperature Rise at Irms	+40°C max.		
Inductance Change at Isat	-25% typical		
Inductance Tolerance	20% (M)		
Resistance to Solder Heat	260°C for 10 seconds		

## DIMENSIONS (mm)

Series	A	B	C
NPIS62H	6.8	7.0	3.0
NPIS64H	6.8	7.0	5.0
NPIS73H	7.8	7.8	4.0
NPIS74H	7.8	7.8	5.0
NPIS14H	10.5	10.5	5.0
NPIS24H	12.5	12.5	5.0
NPIS25H	12.5	12.5	6.0
NPIS27H	12.5	12.5	8.0

## PART NUMBER SYSTEM

NPIS 24 H 560 M TR N F

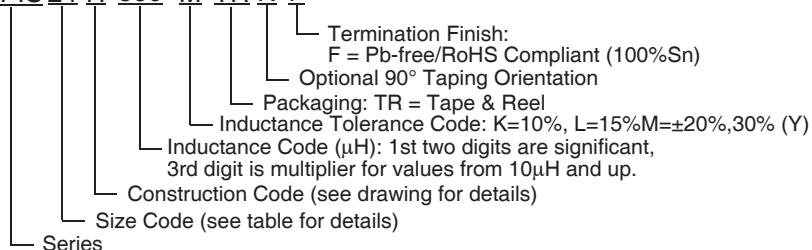

NPIS62, 64H

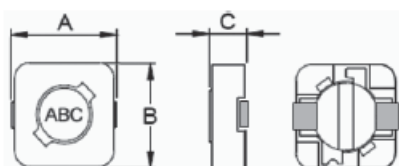

NPIS73, 74H

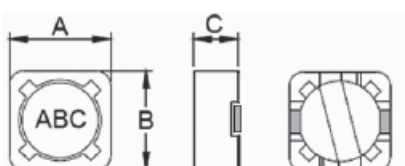

NPIS14, 24, 25, & 27H

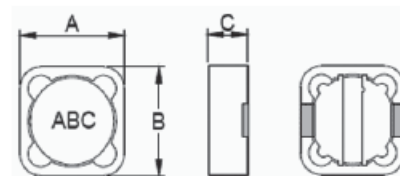

Part Number	Standard Values - Case Size 62 (6.8 x 7.0 x 3.0)			
	Inductance Value ( $\mu$ H)	Test Conditions	DC Resistance ( $\Omega$ )	DC Current Isat/Irms (Amps)
NPIS62H3R3MTRF	3.3 $\pm$ 20%	100k, 0.3V	0.068	1.94
NPIS62H4R7MTRF	4.7 $\pm$ 20%	100k, 0.3V	0.08	1.63
NPIS62H5R6MTRF	5.6 $\pm$ 20%	100k, 0.3V	0.096	1.4
NPIS62H100MTRF	10 $\pm$ 20%	1k, 0.3V	0.015	1.1
NPIS62H120MTRF	12 $\pm$ 20%	1k, 0.3V	0.2	1
NPIS62H150MTRF	15 $\pm$ 20%	1k, 0.3V	0.23	0.9
NPIS62H180MTRF	18 $\pm$ 20%	1k, 0.3V	0.27	0.8
NPIS62H220MTRF	22 $\pm$ 20%	1k, 0.3V	0.34	0.74
NPIS62H270MTRF	27 $\pm$ 20%	1k, 0.3V	0.38	0.66
NPIS62H330MTRF	33 $\pm$ 20%	1k, 0.3V	0.45	0.59
NPIS62H390MTRF	39 $\pm$ 20%	1k, 0.3V	0.49	0.54
NPIS62H470MTRF	47 $\pm$ 20%	1k, 0.3V	0.69	0.5
NPIS62H560MTRF	56 $\pm$ 20%	1k, 0.3V	0.78	0.46
NPIS62H680MTRF	68 $\pm$ 20%	1k, 0.3V	1.07	0.42
NPIS62H820MTRF	82 $\pm$ 20%	1k, 0.3V	1.21	0.38
NPIS62H101MTRF	100 $\pm$ 20%	1k, 0.3V	1.39	0.34
NPIS62H121MTRF	120 $\pm$ 20%	1k, 0.3V	1.9	0.31
NPIS62H151MTRF	150 $\pm$ 20%	1k, 0.3V	2.18	0.28
NPIS62H181MTRF	180 $\pm$ 20%	1k, 0.3V	2.77	0.26
NPIS62H221MTRF	220 $\pm$ 20%	1k, 0.3V	3.12	0.23
NPIS62H271MTRF	270 $\pm$ 20%	1k, 0.3V	4.38	0.22
NPIS62H331MTRF	330 $\pm$ 20%	1k, 0.3V	4.94	0.19

Irms/Isat specification is based on +40°C temperature rise or -25% inductance change whichever is less.



Part Number	Standard Values - Case Size 64 (6.8 x 7.0 x 5.0)			
	Inductance Value ( $\mu$ H)	Test Conditions	DC Resistance ( $\Omega$ )	DC Current Isat/Irms (Amps)
NPIS64H100MTRF	10 $\pm$ 20%	1k, 0.3V	0.12	1.35
NPIS64H120MTRF	12 $\pm$ 20%	1k, 0.3V	0.13	1.2
NPIS64H150MTRF	15 $\pm$ 20%	1k, 0.3V	0.18	1.1
NPIS64H180MTRF	18 $\pm$ 20%	1k, 0.3V	0.24	1
NPIS64H220MTRF	22 $\pm$ 20%	1k, 0.3V	0.27	0.91
NPIS64H270MTRF	27 $\pm$ 20%	1k, 0.3V	0.3	0.82
NPIS64H330MTRF	33 $\pm$ 20%	1k, 0.3V	0.33	0.75
NPIS64H390MTRF	39 $\pm$ 20%	1k, 0.3V	0.37	0.69
NPIS64H470MTRF	47 $\pm$ 20%	1k, 0.3V	0.52	0.62
NPIS64H560MTRF	56 $\pm$ 20%	1k, 0.3V	0.56	0.58
NPIS64H680MTRF	68 $\pm$ 20%	1k, 0.3V	0.63	0.52
NPIS64H820MTRF	82 $\pm$ 20%	1k, 0.3V	0.71	0.47
NPIS64H101MTRF	100 $\pm$ 20%	1k, 0.3V	1.03	0.43
NPIS64H121MTRF	120 $\pm$ 20%	1k, 0.3V	1.15	0.39
NPIS64H151MTRF	150 $\pm$ 20%	1k, 0.3V	1.68	0.35
NPIS64H181MTRF	180 $\pm$ 20%	1k, 0.3V	1.87	0.32
NPIS64H221MTRF	220 $\pm$ 20%	1k, 0.3V	2.08	0.29
NPIS64H271MTRF	270 $\pm$ 20%	1k, 0.3V	2.37	0.26
NPIS64H331MTRF	330 $\pm$ 20%	1k, 0.3V	2.67	0.25
NPIS64H391MTRF	390 $\pm$ 20%	1k, 0.3V	2.94	0.22
NPIS64H471MTRF	470 $\pm$ 20%	1k, 0.3V	3.93	0.2
NPIS64H561MTRF	560 $\pm$ 20%	1k, 0.3V	5.43	0.18
NPIS64H681MTRF	680 $\pm$ 20%	1k, 0.3V	7.32	0.17
NPIS64H821MTRF	820 $\pm$ 20%	1k, 0.3V	8.24	0.15
NPIS64H102MTRF	1000 $\pm$ 20%	1k, 0.3V	9.26	0.14

Irms/Isat specification is based on +40°C temperature rise or -25% inductance change whichever is less.



Part Number	Standard Values - Case Size 73 (7.8 x 7.8 x 4.0)			
	Inductance Value ( $\mu$ H)	Test Conditions	DC Resistance ( $\Omega$ )	DC Current Isat/Irms (Amps)
NPIS73H100MTRF	10 $\pm$ 20%	1k, 0.3V	0.072	1.68
NPIS73H120MTRF	12 $\pm$ 20%	1k, 0.3V	0.098	1.52
NPIS73H150MTRF	15 $\pm$ 20%	1k, 0.3V	0.13	1.33
NPIS73H180MTRF	18 $\pm$ 20%	1k, 0.3V	0.14	1.2
NPIS73H220MTRF	22 $\pm$ 20%	1k, 0.3V	0.19	1.07
NPIS73H270MTRF	27 $\pm$ 20%	1k, 0.3V	0.21	0.96
NPIS73H330MTRF	33 $\pm$ 20%	1k, 0.3V	0.24	0.91
NPIS73H390MTRF	39 $\pm$ 20%	1k, 0.3V	0.32	0.77
NPIS73H470MTRF	47 $\pm$ 20%	1k, 0.3V	0.36	0.76
NPIS73H560MTRF	56 $\pm$ 20%	1k, 0.3V	0.47	0.68
NPIS73H680MTRF	68 $\pm$ 20%	1k, 0.3V	0.52	0.61
NPIS73H820MTRF	82 $\pm$ 20%	1k, 0.3V	0.69	0.57
NPIS73H101MTRF	100 $\pm$ 20%	1k, 0.3V	0.79	0.5
NPIS73H121MTRF	120 $\pm$ 20%	1k, 0.3V	0.89	0.49
NPIS73H151MTRF	150 $\pm$ 20%	1k, 0.3V	1.27	0.43
NPIS73H181MTRF	180 $\pm$ 20%	1k, 0.3V	1.45	0.39
NPIS73H221MTRF	220 $\pm$ 20%	1k, 0.3V	1.65	0.35
NPIS73H271MTRF	270 $\pm$ 20%	1k, 0.3V	2.31	0.32
NPIS73H331MTRF	330 $\pm$ 20%	1k, 0.3V	2.62	0.28
NPIS73H391MTRF	390 $\pm$ 20%	1k, 0.3V	2.94	0.26
NPIS73H471MTRF	470 $\pm$ 20%	1k, 0.3V	4.18	0.24
NPIS73H561MTRF	560 $\pm$ 20%	1k, 0.3V	4.67	0.22
NPIS73H681MTRF	680 $\pm$ 20%	1k, 0.3V	5.73	0.19
NPIS73H821MTRF	820 $\pm$ 20%	1k, 0.3V	6.54	0.18
NPIS73H102MTRF	1000 $\pm$ 20%	1k, 0.3V	9.44	0.16

Irms/Isat specification is based on +40°C temperature rise or -25% inductance change whichever is less.



Part Number	Standard Values - Case Size 74 (7.8 x 7.8 x 5.0)			
	Inductance Value ( $\mu$ H)	Test Conditions	DC Resistance ( $\Omega$ )	DC Current Isat/Irms (Amps)
NPIS74H100MTRF	10 $\pm$ 20%	1k, 0.3V	0.049	1.84
NPIS74H120MTRF	12 $\pm$ 20%	1k, 0.3V	0.058	1.71
NPIS74H150MTRF	15 $\pm$ 20%	1k, 0.3V	0.081	1.47
NPIS74H180MTRF	18 $\pm$ 20%	1k, 0.3V	0.091	1.31
NPIS74H220MTRF	22 $\pm$ 20%	1k, 0.3V	0.11	1.23
NPIS74H270MTRF	27 $\pm$ 20%	1k, 0.3V	0.15	1.12
NPIS74H330MTRF	33 $\pm$ 20%	1k, 0.3V	0.17	0.96
NPIS74H390MTRF	39 $\pm$ 20%	1k, 0.3V	0.23	0.91
NPIS74H470MTRF	47 $\pm$ 20%	1k, 0.3V	0.26	0.88
NPIS74H560MTRF	56 $\pm$ 20%	1k, 0.3V	0.35	0.75
NPIS74H680MTRF	68 $\pm$ 20%	1k, 0.3V	0.38	0.69
NPIS74H820MTRF	82 $\pm$ 20%	1k, 0.3V	0.43	0.61
NPIS74H101MTRF	100 $\pm$ 20%	1k, 0.3V	0.61	0.6
NPIS74H121MTRF	120 $\pm$ 20%	1k, 0.3V	0.66	0.52
NPIS74H151MTRF	150 $\pm$ 20%	1k, 0.3V	0.88	0.46
NPIS74H181MTRF	180 $\pm$ 20%	1k, 0.3V	0.98	0.42
NPIS74H221MTRF	220 $\pm$ 20%	1k, 0.3V	1.17	0.36
NPIS74H271MTRF	270 $\pm$ 20%	1k, 0.3V	1.64	0.34
NPIS74H331MTRF	330 $\pm$ 20%	1k, 0.3V	1.86	0.32
NPIS74H391MTRF	390 $\pm$ 20%	1k, 0.3V	2.85	0.29
NPIS74H471MTRF	470 $\pm$ 20%	1k, 0.3V	3.01	0.26
NPIS74H561MTRF	560 $\pm$ 20%	1k, 0.3V	3.62	0.23
NPIS74H681MTRF	680 $\pm$ 20%	1k, 0.3V	4.63	0.22
NPIS74H821MTRF	820 $\pm$ 20%	1k, 0.3V	5.2	0.2
NPIS74H102MTRF	1000 $\pm$ 20%	1k, 0.3V	6	0.18

Irms/Isat specification is based on +40°C temperature rise or -25% inductance change whichever is less.



Part Number	Standard Values - Case Size 14 (10.5 x 10.5 x 5.0)			
	Inductance Value ( $\mu$ H)	Test Conditions	DC Resistance ( $\Omega$ )	DC Current Isat/Irms (Amps)
NPIS14H4R7MTRF	4.7 $\pm$ 20%	100k, 0.3V	0.035	3.2
NPIS14H6R8MTRF	6.8 $\pm$ 20%	100k, 0.3V	0.044	2.8
NPIS14H100MTRF	10 $\pm$ 20%	1k, 0.3V	0.05	2.4
NPIS14H120MTRF	12 $\pm$ 20%	1k, 0.3V	0.054	2.25
NPIS14H150MTRF	15 $\pm$ 20%	1k, 0.3V	0.061	2
NPIS14H180MTRF	18 $\pm$ 20%	1k, 0.3V	0.084	1.8
NPIS14H220MTRF	22 $\pm$ 20%	1k, 0.3V	0.094	1.65
NPIS14H270MTRF	27 $\pm$ 20%	1k, 0.3V	0.11	1.45
NPIS14H330MTRF	33 $\pm$ 20%	1k, 0.3V	0.15	1.35
NPIS14H390MTRF	39 $\pm$ 20%	1k, 0.3V	0.17	1.2
NPIS14H470MTRF	47 $\pm$ 20%	1k, 0.3V	0.21	1.1
NPIS14H560MTRF	56 $\pm$ 20%	1k, 0.3V	0.23	1
NPIS14H680MTRF	68 $\pm$ 20%	1k, 0.3V	0.26	0.93
NPIS14H820MTRF	82 $\pm$ 20%	1k, 0.3V	0.36	0.84
NPIS14H101MTRF	100 $\pm$ 20%	1k, 0.3V	0.41	0.76
NPIS14H151MTRF	150 $\pm$ 20%	1k, 0.3V	0.64	0.63
NPIS14H181MTRF	180 $\pm$ 20%	1k, 0.3V	0.84	0.57
NPIS14H221MTRF	220 $\pm$ 20%	1k, 0.3V	0.96	0.52
NPIS14H271MTRF	270 $\pm$ 20%	1k, 0.3V	1.07	0.47
NPIS14H331MTRF	330 $\pm$ 20%	1k, 0.3V	1.37	0.43
NPIS14H391MTRF	390 $\pm$ 20%	1k, 0.3V	1.55	0.39
NPIS14H471MTRF	470 $\pm$ 20%	1k, 0.3V	1.74	0.36

Irms/Isat specification is based on +40°C temperature rise or -25% inductance change whichever is less.

Part Number	Standard Values - Case Size 24 (12.5 x 12.5 x 5.0)			
	Inductance Value ( $\mu$ H)	Test Conditions	DC Resistance ( $\Omega$ )	DC Current Isat/Irms (Amps)
NPIS24H1R0MTRF	1.0 $\pm$ 20%	100k, 0.3V	0.010	8.0
NPIS24H2R2MTRF	2.2 $\pm$ 20%	100k, 0.3V	0.014	4.9
NPIS24H3R3MTRF	3.3 $\pm$ 20%	100k, 0.3V	0.015	4.5
NPIS24H4R7MTRF	4.7 $\pm$ 20%	100k, 0.3V	0.018	5.7
NPIS24H5R6MTRF	5.6 $\pm$ 20%	100k, 0.3V	0.020	5.2
NPIS24H6R8MTRF	6.8 $\pm$ 20%	100k, 0.3V	0.023	4.9
NPIS24H8R2MTRF	8.2 $\pm$ 20%	100k, 0.3V	0.026	4.6
NPIS24H100MTRF	10 $\pm$ 20%	1k, 0.3V	0.028	4.5
NPIS24H120MTRF	12 $\pm$ 20%	1k, 0.3V	0.038	4.0
NPIS24H150MTRF	15 $\pm$ 20%	1k, 0.3V	0.050	3.2
NPIS24H180MTRF	18 $\pm$ 20%	1k, 0.3V	0.057	3.1
NPIS24H220MTRF	22 $\pm$ 20%	1k, 0.3V	0.066	2.9
NPIS24H270MTRF	27 $\pm$ 20%	1k, 0.3V	0.080	2.8
NPIS24H330MTRF	33 $\pm$ 20%	1k, 0.3V	0.097	2.7
NPIS24H390MTRF	39 $\pm$ 20%	1k, 0.3V	0.132	2.1
NPIS24H470MTRF	47 $\pm$ 20%	1k, 0.3V	0.16	1.9
NPIS24H560MTRF	56 $\pm$ 20%	1k, 0.3V	0.19	1.8
NPIS24H680MTRF	68 $\pm$ 20%	1k, 0.3V	0.22	1.5
NPIS24H820MTRF	82 $\pm$ 20%	1k, 0.3V	0.26	1.3
NPIS24H101MTRF	100 $\pm$ 20%	1k, 0.3V	0.31	1.2
NPIS24H121MTRF	120 $\pm$ 20%	1k, 0.3V	0.38	1.1
NPIS24H151MTRF	150 $\pm$ 20%	1k, 0.3V	0.53	0.95
NPIS24H181MTRF	180 $\pm$ 20%	1k, 0.3V	0.62	0.85
NPIS24H221MTRF	220 $\pm$ 20%	1k, 0.3V	0.70	0.80
NPIS24H271MTRF	270 $\pm$ 20%	1k, 0.3V	0.87	0.60
NPIS24H331MTRF	330 $\pm$ 20%	1k, 0.3V	0.99	0.50

Irms/Isat specification is based on +40°C temperature rise or -25% inductance change whichever is less.



Part Number	Standard Values - Case Size 25 (12.5 x 12.5 x 6.0)			
	Inductance Value ( $\mu$ H)	Test Conditions	DC Resistance ( $\Omega$ )	DC Current Isat/Irms (Amps)
NPIS25H1R0MTRF	1.0 $\pm$ 20%	100k, 0.3V	0.01	8
NPIS25H2R2MTRF	2.2 $\pm$ 20%	100k, 0.3V	0.014	7.8
NPIS25H3R3MTRF	3.3 $\pm$ 20%	100k, 0.3V	0.014	8
NPIS25H8R2MTRF	8.2 $\pm$ 20%	100k, 0.3V	0.021	4.4
NPIS25H100MTRF	10 $\pm$ 20%	1k, 0.3V	0.025	4
NPIS25H120MTRF	12 $\pm$ 20%	1k, 0.3V	0.027	3.5
NPIS25H150MTRF	15 $\pm$ 20%	1k, 0.3V	0.03	3.3
NPIS25H180MTRF	18 $\pm$ 20%	1k, 0.3V	0.034	3
NPIS25H220MTRF	22 $\pm$ 20%	1k, 0.3V	0.036	2.8
NPIS25H270MTRF	27 $\pm$ 20%	1k, 0.3V	0.051	2.3
NPIS25H330MTRF	33 $\pm$ 20%	1k, 0.3V	0.057	2.1
NPIS25H390MTRF	39 $\pm$ 20%	1k, 0.3V	0.068	2
NPIS25H470MTRF	47 $\pm$ 20%	1k, 0.3V	0.075	1.8
NPIS25H560MTRF	56 $\pm$ 20%	1k, 0.3V	0.11	1.7
NPIS25H680MTRF	68 $\pm$ 20%	1k, 0.3V	0.12	1.5
NPIS25H820MTRF	82 $\pm$ 20%	1k, 0.3V	0.14	1.4
NPIS25H101MTRF	100 $\pm$ 20%	1k, 0.3V	0.16	1.3
NPIS25H121MTRF	120 $\pm$ 20%	1k, 0.3V	0.17	1.1
NPIS25H151MTRF	150 $\pm$ 20%	1k, 0.3V	0.23	1
NPIS25H181MTRF	180 $\pm$ 20%	1k, 0.3V	0.29	0.9
NPIS25H221MTRF	220 $\pm$ 20%	1k, 0.3V	0.4	0.8
NPIS25H271MTRF	270 $\pm$ 20%	1k, 0.3V	0.46	0.75
NPIS25H331MTRF	330 $\pm$ 20%	1k, 0.3V	0.51	0.68
NPIS25H391MTRF	390 $\pm$ 20%	1k, 0.3V	0.69	0.65
NPIS25H471MTRF	470 $\pm$ 20%	1k, 0.3V	0.77	0.58
NPIS25H561MTRF	560 $\pm$ 20%	1k, 0.3V	0.86	0.54
NPIS25H681MTRF	680 $\pm$ 20%	1k, 0.3V	1.2	0.48
NPIS25H821MTRF	820 $\pm$ 20%	1k, 0.3V	1.34	0.43
NPIS25H102MTRF	1000 $\pm$ 20%	1k, 0.3V	1.53	0.40

Irms/Isat specification is based on +40°C temperature rise or -25% inductance change whichever is less.



Part Number	Standard Values - Case Size 27 (12.5 x 12.5 x 8.0)			
	Inductance Value ( $\mu\text{H}$ )	Test Conditions	DC Resistance ( $\Omega$ )	DC Current $I_{\text{sat}}/I_{\text{rms}}$ (Amps)
NPIS27H1R0MTRF	1.0 $\pm$ 20%	100k, 0.3V	0.006	12
NPIS27H1R2MTRF	1.2 $\pm$ 20%	100k, 0.3V	0.008	8
NPIS27H2R2MTRF	2.2 $\pm$ 20%	100k, 0.3V	0.0115	8
NPIS27H3R3MTRF	3.3 $\pm$ 20%	100k, 0.3V	0.013	8
NPIS27H4R7MTRF	4.7 $\pm$ 20%	100k, 0.3V	0.0158	6.8
NPIS27H6R8MTRF	6.8 $\pm$ 20%	100k, 0.3V	0.019	6.6
NPIS27H8R2MTRF	8.2 $\pm$ 20%	100k, 0.3V	0.02	5.6
NPIS27H100MTRF	10 $\pm$ 20%	1k, 0.3V	0.0216	5.4
NPIS27H120MTRF	12 $\pm$ 20%	1k, 0.3V	0.0243	4.9
NPIS27H150MTRF	15 $\pm$ 20%	1k, 0.3V	0.027	4.5
NPIS27H180MTRF	18 $\pm$ 20%	1k, 0.3V	0.0392	3.9
NPIS27H220MTRF	22 $\pm$ 20%	1k, 0.3V	0.0432	3.6
NPIS27H270MTRF	27 $\pm$ 20%	1k, 0.3V	0.0459	3.4
NPIS27H330MTRF	33 $\pm$ 20%	1k, 0.3V	0.0648	3
NPIS27H390MTRF	39 $\pm$ 20%	1k, 0.3V	0.0729	2.75
NPIS27H470MTRF	47 $\pm$ 20%	1k, 0.3V	0.1	2.5
NPIS27H560MTRF	56 $\pm$ 20%	1k, 0.3V	0.11	2.35
NPIS27H680MTRF	68 $\pm$ 20%	1k, 0.3V	0.14	2.1
NPIS27H820MTRF	82 $\pm$ 20%	1k, 0.3V	0.16	1.95
NPIS27H101MTRF	100 $\pm$ 20%	1k, 0.3V	0.22	1.7
NPIS27H121MTRF	120 $\pm$ 20%	1k, 0.3V	0.25	1.6
NPIS27H151MTRF	150 $\pm$ 20%	1k, 0.3V	0.28	1.42
NPIS27H181MTRF	180 $\pm$ 20%	1k, 0.3V	0.35	1.3
NPIS27H221MTRF	220 $\pm$ 20%	1k, 0.3V	0.39	1.16
NPIS27H271MTRF	270 $\pm$ 20%	1k, 0.3V	0.56	1.06
NPIS27H331MTRF	330 $\pm$ 20%	1k, 0.3V	0.64	0.95
NPIS27H391MTRF	390 $\pm$ 20%	1k, 0.3V	0.7	0.88
NPIS27H471MTRF	470 $\pm$ 20%	1k, 0.3V	0.98	0.79
NPIS27H561MTRF	560 $\pm$ 20%	1k, 0.3V	1.07	0.73
NPIS27H681MTRF	680 $\pm$ 20%	1k, 0.3V	1.46	0.67
NPIS27H821MTRF	820 $\pm$ 20%	1k, 0.3V	1.64	0.6
NPIS27H102MTRF	1000 $\pm$ 20%	1k, 0.3V	1.82	0.55

$I_{\text{rms}}/I_{\text{sat}}$  specification is based on +40°C temperature rise or -25% inductance change whichever is less.



## RECOMMENDED LAND PATTERN DIMENSIONS

Series	G	H	L
NPIS62H	4.6	1.9	7.4
NPIS64H	4.6	1.9	7.4
NPIS73H	4.8	2.2	8.0
NPIS74H	4.8	2.2	8.0
NPIS14H	6.8	4.4	10.8
NPIS24H	7.0	5.4	12.8
NPIS25H	7.0	5.4	12.8
NPIS27H	7.0	5.4	12.8

### LAND PATTERN

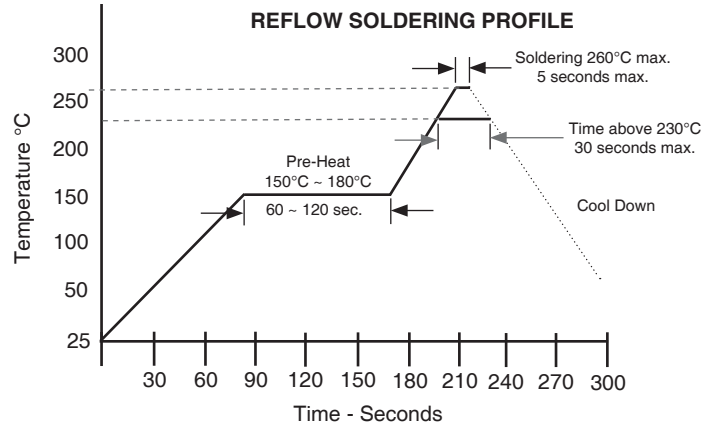
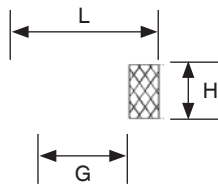

Case Size	TAPING DIMENSIONS (mm)					
	Ao	Bo	Ko	Co	W	Po
NPIS62H	7.0	6.6	3.2	7.5	16	12
NPIS64H	7.0	6.6	5.2	7.5	16	12
NPIS73H	7.6	7.6	4.2	7.5	16	12
NPIS74H			5.2			
NPIS14H	10.3	10.3	5.2	11.5	24	16
NPIS24H	12.9	12.9	4.9	11.5	24	16.0
NPIS25H			6.2			
NPIS27H			8.2			

### STANDARD COMPONENT ORIENTATION ON TAPE (TRF)

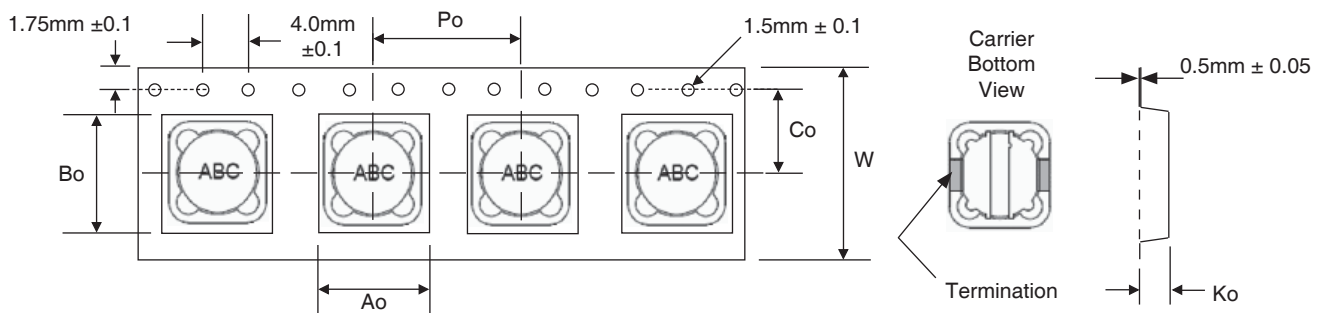

### OPTIONAL COMPONENT ORIENTATION ON TAPE (TRNF)

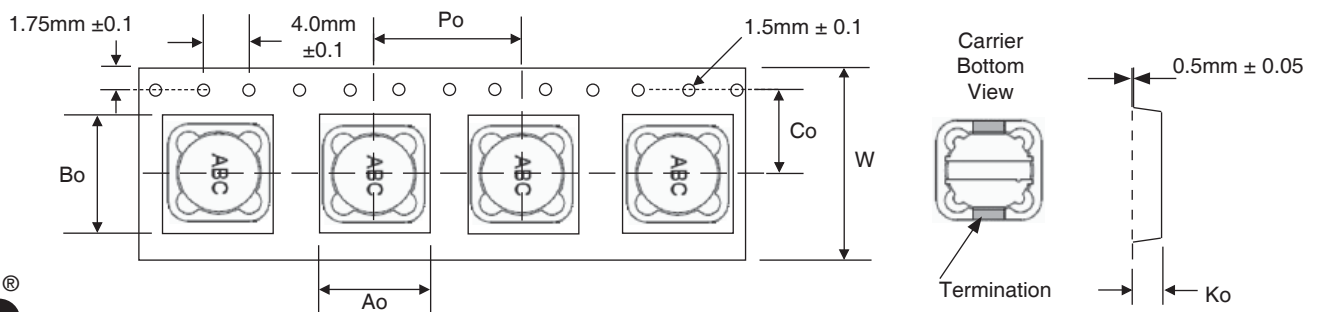

Tape Width	REEL DIMENSIONS (mm)			
	A(mm)	B(mm)	C(mm)	D(mm)
16mm	16.5 ± 0.5	100 ± 2.0	13 ± 0.5	330
24mm	24.5 ± 0.1	100 ± 2.0	13 ± 0.5	330

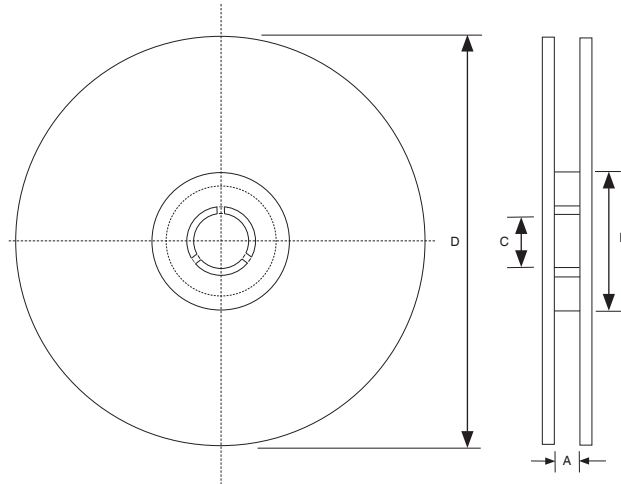

Size	REEL QUANTITY PER CASE SIZE							
	NPIS62H	NPIS64H	NPIS73H	NPIS74H	NPIS14H	NPIS24H	NPIS25H	NPIS27H
Quantity per reel	1,500	1,000	1,000	1,000	1,000	600	600	400
Tape Width	16mm				24mm			

