

NPIS-A Series

Shielded Power Inductors



FEATURES

- SHIELDED POWER INDUCTOR
- HIGH CURRENT RATINGS TO 48AMPS
- SURFACE MOUNTABLE CONSTRUCTION
- TAPED AND REELED FOR AUTOMATIC INSERTION
- FOR USE IN DC/DC CONVERTERS



AVAILABLE CASE SIZES, VALUES AND CHARACTERISTICS

Case Size	NPIS75A	NPIS105A	NPIS117A	NPIS119A	NPIS138A
Inductance Range	0.072 μ H ~ 0.15 μ H	0.085 μ H ~ 0.22 μ H	0.070 μ H ~ 0.51 μ H	0.225 μ H ~ 0.47 μ H	0.21 μ H ~ 0.44 μ H
Ambient Operating Temperature Range	-40°C ~ +125°C (Including self-heating)				
Temperature Rise at Irms	+40°C typ.				
Inductance Change at Isat	-20% typ.				
Inductance Tolerance	See case size and specifications tables				
Resistance to Solder Heat	+260°C for 10 seconds				

Application Note: The NPIS-A series parts are not suitable for use in synchronous rectification circuits.

DIMENSIONS (mm)

Series	A max.	B max.	C max.	D typ.	E typ.
NPIS75A	7.0	7.0	4.96	1.52	2.49
NPIS105A	10.2	7.0	4.96	1.52	2.49
NPIS117A	11.0	7.2	7.8	2.54	1.55
NPIS119A	11.2	11.2	9.0	2.54	2.03
NPIS138A	13.46	12.95	8.0	2.54	5.08

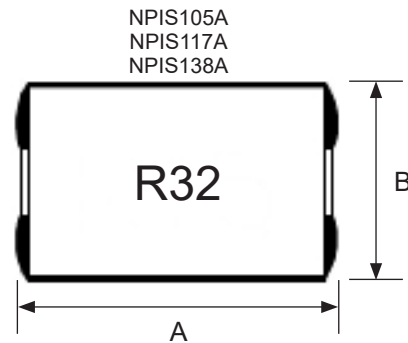
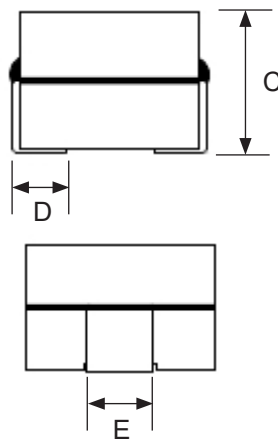
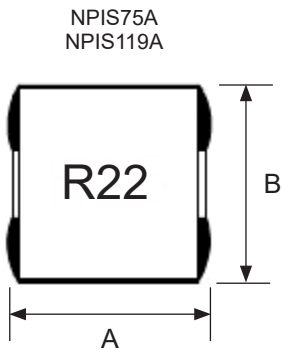

NPIS-A Series

Shielded Power Inductors



PART NUMBER SYSTEM

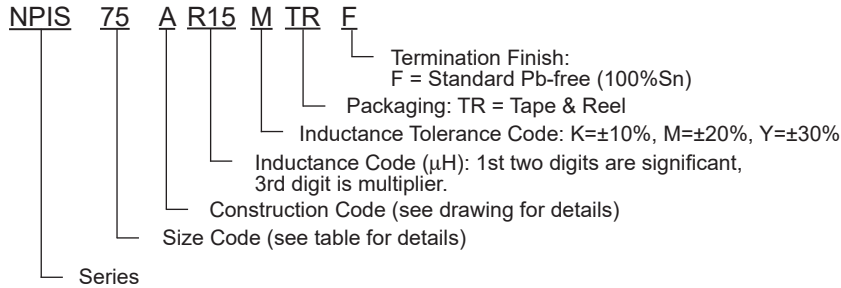

PART NUMBERS AND SPECIFICATIONS

Part Number	Standard Values - Case Size 75 (7.0 x 7.0 x 4.96mm)					
	Inductance Value (μH)	Available Tolerance	Test Conditions	DCR max. (mΩ)	DC Current Isat (Arms)	DC Current Irms (Arms)
NPIS75AR072_TRF	0.072	±20% (M), ±30% (Y)	100kHz/0.1V	0.35	58	31
NPIS75AR10_TRF	0.1	±20% (M), ±30% (Y)	100kHz/0.1V	0.35	46	31
NPIS75AR15_TRF	0.15	±20% (M), ±30% (Y)	100kHz/0.1V	0.35	30	31

Irms/Isat specification is based on +40°C temperature rise or -20% inductance change whichever is less.

Part Number	Standard Values - Case Size 105 (10.2 x 7.0 x 4.96mm)					
	Inductance Value (μH)	Available Tolerance	Test Conditions	DCR max. (mΩ)	DC Current Isat (Arms)	DC Current Irms (Arms)
NPIS105AR085_TRF	0.085	±20% (M), ±30% (Y)	100kHz/0.1V	0.42	70	31
NPIS105AR10_TRF	0.1	±20% (M)	100kHz/0.1V	0.42	70	31
NPIS105AR12_TRF	0.12	±20% (M)	100kHz/0.1V	0.42	52	31
NPIS105AR155_TRF	0.155	±20% (M)	100kHz/0.1V	0.42	40	31
NPIS105AR22_TRF	0.22	±20% (M)	100kHz/0.1V	0.42	33	25

Irms/Isat specification is based on +40°C temperature rise or -20% inductance change whichever is less.

Part Number	Standard Values - Case Size 117 (11.0 x 7.2 x 7.8mm)					
	Inductance Value (μH)	Available Tolerance	Test Conditions	DCR max. (mΩ)	DC Current Isat (Arms)	DC Current Irms (Arms)
NPIS117A070_TRF	0.07	±15% (L), ±20% (M)	100kHz/1.0V	0.32	70	48
NPIS117AR10_TRF	0.1	±15% (L), ±20% (M)	100kHz/1.0V	0.32	70	48
NPIS117AR12_TRF	0.12	±15% (L), ±20% (M)	100kHz/1.0V	0.32	70	48
NPIS117AR15_TRF	0.15	±15% (L), ±20% (M)	100kHz/1.0V	0.32	70	48
NPIS117AR22_TRF	0.22	±15% (L), ±20% (M)	100kHz/1.0V	0.32	47	48
NPIS117AR23_TRF	0.23	±10% (K), ±15% (L), ±20% (M)	100kHz/1.0V	0.32	44	48
NPIS117AR30_TRF	0.3	±15% (L), ±20% (M)	100kHz/1.0V	0.32	32	48
NPIS117AR40_TRF	0.4	±15% (L), ±20% (M)	100kHz/1.0V	0.32	23	48
NPIS117AR51_TRF	0.51	±15% (L), ±20% (M)	100kHz/1.0V	0.32	17	48

Irms/Isat specification is based on +40°C temperature rise or -20% inductance change whichever is less.

Performance Passives By Design

NPIS-A Series

Shielded Power Inductors



Part Number	Standard Values - Case Size 119 (11.2 x 11.2 x 9.0mm)					
	Inductance Value (μH)	Available Tolerance	Test Conditions	DCR max. (mΩ)	DC Current Isat (Arms)	DC Current Irms (Arms)
NPIS119AR225_TRF	0.225	±20% (M), ±30% (Y)	100kHz/0.1V	0.69	68	35
NPIS119AR27_TRF	0.27	±20% (M), ±30% (Y)	100kHz/0.1V	0.69	50	35
NPIS119AR325_TRF	0.325	±20% (M), ±30% (Y)	100kHz/0.1V	0.69	43	35
NPIS119AR47_TRF	0.47	±20% (M), ±30% (Y)	100kHz/0.1V	0.69	30	35

Irms/Isat specification is based on +40°C temperature rise or -20% inductance change whichever is less.

Part Number	Standard Values - Case Size 138 (13.46 x 12.95 x 8.0mm)					
	Inductance Value (μH)	Available Tolerance	Test Conditions	DCR max. (mΩ)	DC Current Isat (Arms)	DC Current Irms (Arms)
NPIS138AR21_TRF	0.21	±20% (M), ±30% (Y)	100kHz/0.1V	0.35	71	45
NPIS138AR26_TRF	0.26	±20% (M), ±30% (Y)	100kHz/0.1V	0.35	60	45
NPIS138AR32_TRF	0.32	±20% (M), ±30% (Y)	100kHz/0.1V	0.35	50	45
NPIS138AR44_TRF	0.44	±20% (M), ±30% (Y)	100kHz/0.1V	0.35	35	45

Irms/Isat specification is based on +40°C temperature rise or -20% inductance change whichever is less.

LAND PATTERN DIMENSIONS (mm)

Series	A	B	C
NPIS75A	2.03	3.30	3.05
NPIS105A	2.03	6.35	3.05
NPIS117A	3.56	4.06	2.54
NPIS119A	3.05	5.33	2.54
NPIS138A	3.18	7.11	7.62

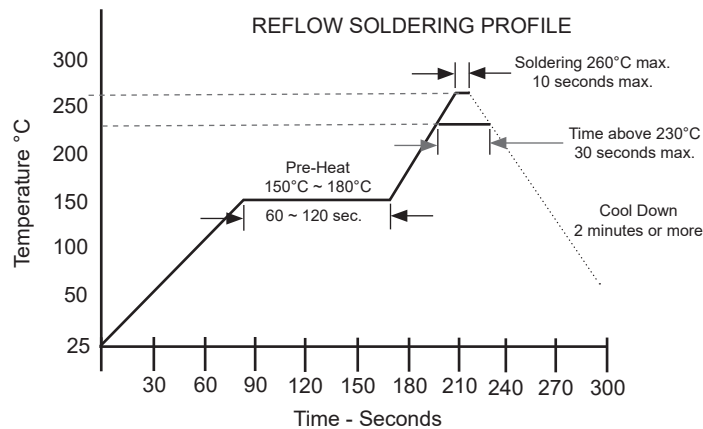
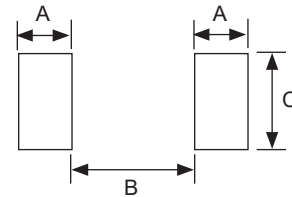

NPIS-A Series

Shielded Power Inductors



CARRIER TAPE DIMENSIONS (mm)

Series	Reel Quantity	CARRIER TAPE DIMENSIONS (mm)					
		W ± 0.2	Ao	Bo	Co ± 0.1	Ko	Po
NPIS75A	1,000	16.0	7.4	7.4	7.5	5.2	12.0
NPIS105A	800	24.0	7.5	11.8	11.5	5.4	12.0
NPIS117A	500	24.0	7.6	11.5	11.5	8.1	12.0
NPIS119A	350	24.0	11.6	11.6	11.5	9.4	16.0
NPIS138A	300	24.0	12.97	12.97	11.5	8.2	24.0

TRF TAPING DIMENSIONS

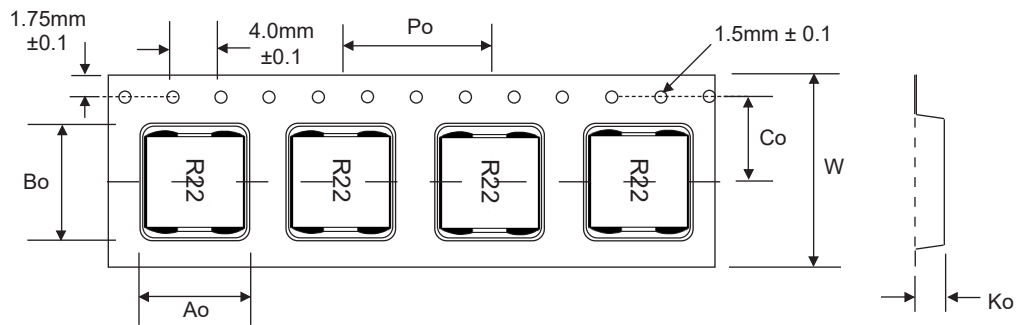

Tape Width (mm)	REEL DIMENSIONS (mm)		
	A	B ± 0.5	C ± 0.2
16.0	330	20.0	13.0
24.0			

