

## FEATURES

- MINIATURE SIZE (6.5mm X 5.2mm)
- LOW PROFILE (1.05mm ~ 2.55mm MAXIMUM HEIGHT)
- SURFACE MOUNTABLE CONSTRUCTION
- TAPED AND REELED FOR AUTOMATIC INSERTION

**RoHS  
Compliant**  
includes all homogeneous materials



\*See Part Number System for Details

## CHARACTERISTICS

Case Size	NPI21S	NPI22S	NPI23S	NPI24S
Inductance Range	2.2μH ~ 47μH		100μH ~ 1,000μH	100μH ~ 3,300μH
Inductance Tolerance	±20% (M)			
Operating Temperature Range	-25°C ~ +85°C			
Inductance Change at Isat	-10% max.			
Temperature Rise at Isat	+40°C max.			
Resistance to Solder Heat	260°C for 10 seconds (Inductance change ±10% max.)			

## CASE DIMENSIONS (mm)

Series	A	B	C	D	L	L <sub>1</sub>	W	W <sub>1</sub>	T
NPI21S	4.8±0.1	3.0±0.1	0.5±0.1	0.4±0.1	5.2±0.1	5.0±0.1	6.5 max.	5.0±0.1	1.05 max.
NPI22S									1.25 max.
NPI23S									1.55 max.
NPI24S									2.55 max.

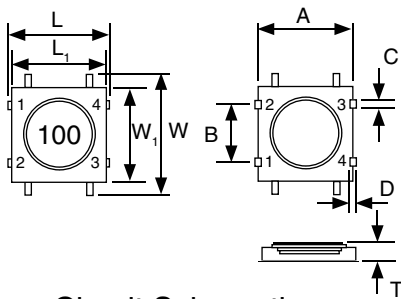

Circuit Schematic



## PART NUMBER SYSTEM

NPI 21 S 220 M TR E

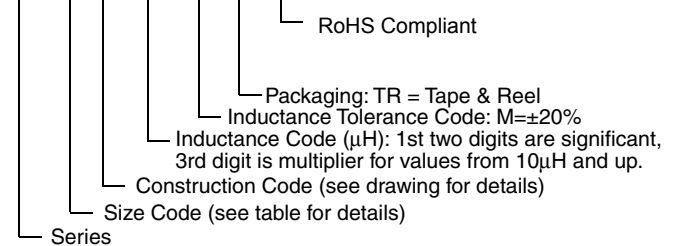

## LAND PATTERN DIMENSIONS (mm)

Series	L	G	G <sub>1</sub>	H
NPI_S	5.4	4.2	2.2	3.8

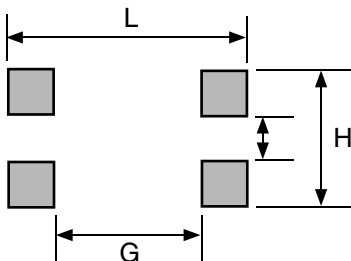

## REFLOW SOLDERING PROFILE

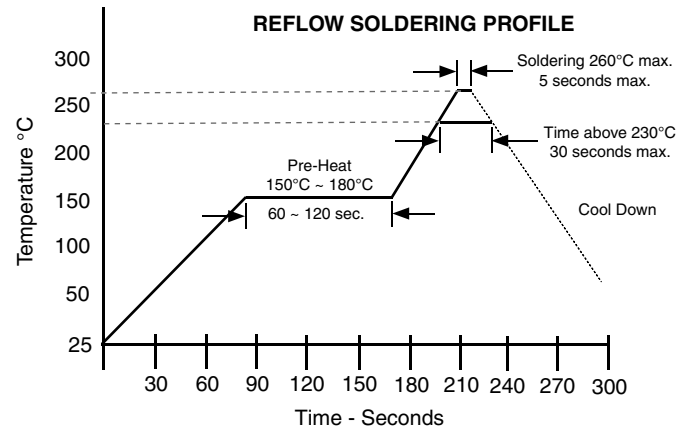

Part Number	STANDARD VALUES - 21 CASE SIZE (6.5 x 5.2 x 1.05mm)				
	Inductance Value (μH)	DC Resistance (Ω)	DC Current (Irms)	DC Current (Isat)	Test Frequency
NPI21S2R2MTRF	2.2±20%	0.18	0.51	1.70	100KHz
NPI21S3R3MTRF	3.3±20%	0.22	0.46	1.50	
NPI21S4R7MTRF	4.7±20%	0.28	0.41	1.32	
NPI21S6R8MTRF	6.8±20%	0.38	0.35	1.12	
NPI21S100MTRF	10±20%	0.61	0.27	0.90	
NPI21S150MTRF	15±20%	0.82	0.24	0.73	
NPI21S220MTRF	22±20%	1.10	0.20	0.62	
NPI21S330MTRF	33±20%	1.88	0.15	0.52	
NPI21S470MTRF	47±20%	2.34	0.14	0.42	

Part Number	STANDARD VALUES - 22 CASE SIZE (6.5 x 5.2 x 1.25mm)				
	Inductance Value (μH)	DC Resistance (Ω)	DC Current (Irms)	DC Current (Isat)	Test Frequency
NPI22S2R2MTRF	2.2±20%	0.18	0.55	1.97	100KHz
NPI22S3R3MTRF	3.3±20%	0.22	0.50	1.82	
NPI22S4R7MTRF	4.7±20%	0.27	0.45	1.54	
NPI22S6R8MTRF	6.8±20%	0.37	0.38	1.30	
NPI22S100MTRF	10±20%	0.48	0.33	1.10	
NPI22S150MTRF	15±20%	0.62	0.29	0.95	
NPI22S220MTRF	22±20%	1.00	0.23	0.77	
NPI22S330MTRF	33±20%	1.40	0.19	0.6	
NPI22S470MTRF	47±20%	2.16	0.15	0.51	

Part Number	STANDARD VALUES - 23 CASE SIZE (6.5 x 5.2 x 1.55mm)				
	Inductance Value (μH)	DC Resistance (Ω)	DC Current (Irms)	DC Current (Isat)	Test Frequency
NPI23S101MTRF	100±20%	3.2	0.160	0.50	100KHz
NPI23S151MTRF	150±20%	5.0	0.130	0.35	
NPI23S221MTRF	220±20%	6.5	0.115	0.30	
NPI23S331MTRF	330±20%	12	0.085	0.22	
NPI23S471MTRF	470±20%	22	0.060	0.17	
NPI23S631MTRF	630±20%	27	0.055	0.15	
NPI23S102MTRF	1000±20%	33	0.050	0.13	

Part Number	STANDARD VALUES - 24 CASE SIZE (6.5 x 5.2 x 2.55mm)				
	Inductance Value (μH)	DC Resistance (Ω)	DC Current (Irms)	DC Current (Isat)	Test Frequency
NPI24S101MTRF	100±20%	1.6	0.240	0.45	100KHz
NPI24S151MTRF	150±20%	2.5	0.190	0.35	
NPI24S221MTRF	220±20%	3.8	0.160	0.30	
NPI24S331MTRF	330±20%	5.9	0.130	0.25	
NPI24S471MTRF	470±20%	7.5	0.110	0.22	
NPI24S681MTRF	680±20%	12	0.090	0.18	
NPI24S102MTRF	1000±20%	20	0.070	0.14	
NPI24S152MTRF	1500±20%	25	0.060	0.12	
NPI24S222MTRF	2200±20%	45	0.045	0.09	
NPI24S332MTRF	3300±20%	60	0.040	0.08	

Maximum +40°C temperature rise at Irms. Maximum -10% inductance change at Isat.



Case Size	TAPING DIMENSIONS (mm)						
	Ao	Bo	Ko	Co	W	Po	Qty/Reel
NPI21S	5.45 ±0.1	6.75 ±0.1	1.40 ±0.1	7.50 ±0.1	16.0	8.0	3,000
NPI22S			1.75 ±0.1				
NPI23S			2.80 ±0.1				
NPI24S							

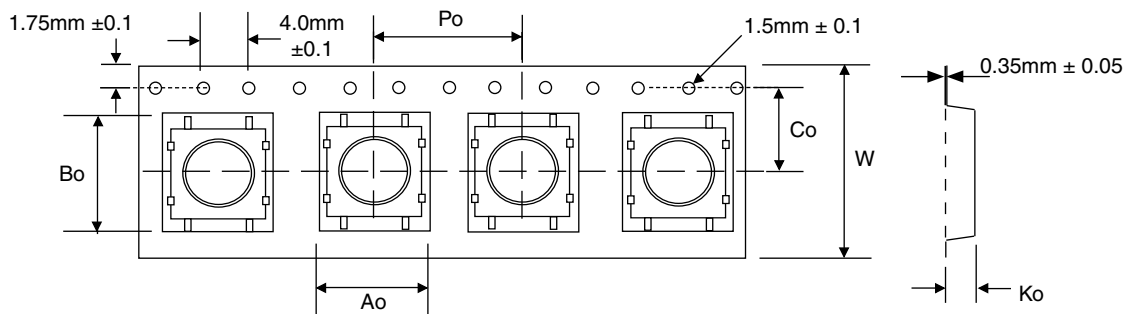

Tape Width	REEL DIMENSIONS (mm)			
	A(mm)	B(mm)	C(mm)	D(mm)
16mm	18.0 +0	50 -0	13 ±0.5	330

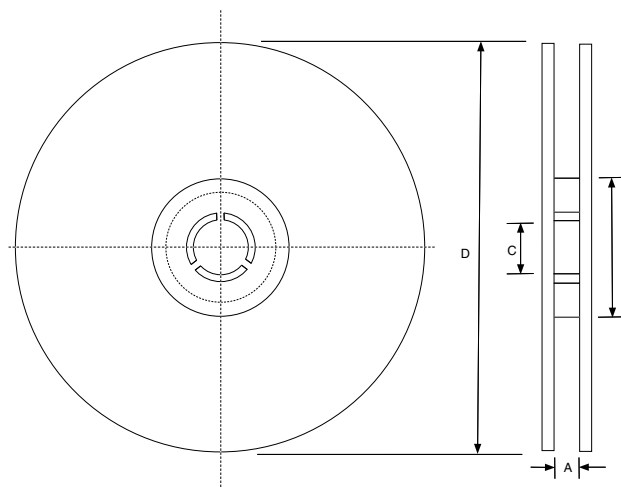

# Isat and Irms

## NPI & NPIS Series

**Isat (Saturation Current)** - is the current required to **decrease the inductance** value by the specified maximum amount (given as a percentage of the nominal inductance value).

**Irms** - is the current required to **increase the temperature** of the part a maximum specified amount (given as a temperature rise in °C).

In some instances Isat and Irms are shown separately with a maximum decrease in inductance specified at one current rating (Isat) and a maximum temperature rise specified at another current rating (Irms). In other cases one current value is given for both (specified as Idc) and represents the current at which a specified maximum inductance decrease and a maximum specified temperature rise can occur. The graph below illustrates change in inductance and temperature as current increases.

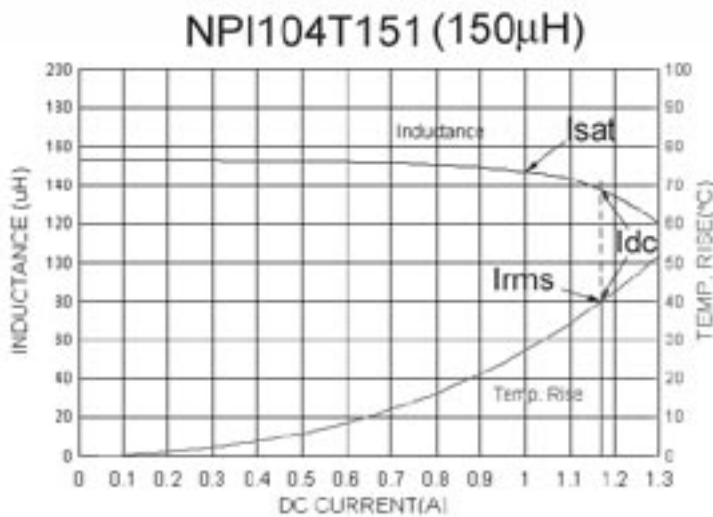

Based on the above graph Isat and Irms could be expressed as follows:

1. Isat and Irms can be shown as separate current values. The Isat current is a value of current that could potentially produce a specified maximum inductance change [-5%, -10%, -20%, etc. of the nominal value]. In this case a 1.0A current has produced a -5% inductance change so 1.0A could be specified as the inductor's Isat current rating. The Irms could be expressed as the current that produces a +40°C temperature rise which in this case is about 1.18A.
2. Both Isat and Irms can be expressed using one current value (Idc). In the above graph 1.18A could be specified as the Idc for the part noting that at 1.18A a potential +40°C temperature rise (equivalent to Irms) and a -10% change in inductance (equivalent to Isat) could occur.