

Miniature Aluminum Electrolytic Capacitors

NRE-LS Series

REDUCED SIZE, EXTENDED RANGE
LOW PROFILE, RADIAL LEAD, POLARIZED

FEATURES

- LOW PROFILE APPLICATIONS
- HIGH STABILITY AND PERFORMANCE

RoHS
Compliant
includes all homogeneous materials

*See Part Number System for Details

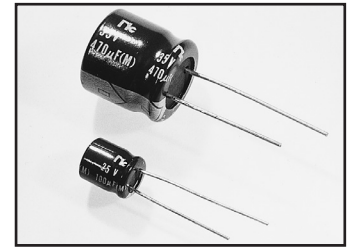

CHARACTERISTICS

Rated Voltage Range	6.3 ~ 50Vdc						
Capacitance Range	22 ~ 10,000 μ F						
Operating Temperature Range	-40 ~ +85°C						
Capacitance Tolerance	\pm 20%(M)						
Max. Leakage Current @ 20°C	After 1 min.	0.03CV or 4 μ A, whichever is greater					
	After 2 min.	0.01CV or 3 μ A, whichever is greater					
Max. Tan δ @ 120Hz/+20°C	W.V. (Vdc)	6.3	10	16	25	35	50
	S.V. (Vdc)	8	13	20	32	44	63
	C \leq 1,000 μ F	0.28	0.24	0.20	0.16	0.14	0.12
	C = 2,200 μ F	-	-	0.22	0.18	0.16	0.14
	C = 3,300 μ F	0.32	0.28	-	0.20	-	-
	C = 4,700 μ F	0.34	-	0.26	-	-	-
	C = 6,800 μ F	0.36	0.32	-	-	-	-
Low Temperature Stability Impedance Ratio @ 120Hz	Z-25°C/Z+20°C	5	4	3	2	2	2
	Z-40°C/Z+20°C	12	10	8	5	4	4
Load Life Test at Rated W.V. +85°C 2,000 Hours	Capacitance Change	Within \pm 25% of initial measured value					
	Tan δ	Less than 200% of specified maximum value					
	Leakage Current	Less than specified maximum value					

STANDARD PRODUCT AND CASE SIZE TABLE D ϕ x L (mm)

Cap. (μ F)	Code	Working Voltage (Vdc)					
		6.3	10	16	25	35	50
220	221	-	-	-	-	10x9	-
330	331	-	-	-	10x9	-	-
470	471	-	-	10x9	-	-	16x16
1,000	102	10x9	-	-	-	16x16	16x21
2,200	222	-	-	16x16	16x16	18x21	18x25
3,300	332	16x16	16x16	-	18x21	-	-
4,700	472	16x16	-	18x21	-	-	-
6,800	682	-	18x21	-	-	-	-
10,000	103	18x21	-	-	-	-	-

LEAD SPACING AND DIAMETER (mm)

Case Dia. (D ϕ)	5	6.3	8	10	12.5	16	18
Lead Dia. (d ϕ)	0.5	0.5	0.6	0.6	0.6	0.8	0.8
Lead Spacing (F)	2.0	2.5	3.5	5.0	5.0	7.5	7.5
Dim. α	0.5	0.5	0.5	0.5	0.5	0.5	0.5
dim. β	1.5	1.5	1.5	1.5	1.5	2.0	2.0

DIMENSIONS (mm)

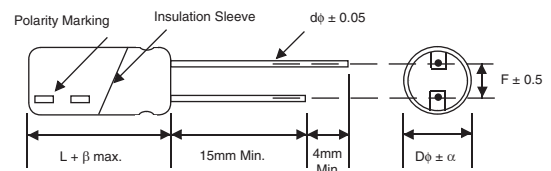

Drawing is representative of parts as supplied in bulk or straight lead format, please see taping specifications for details on taped format packaging.

PRECAUTIONS

Please review the notes on correct use, safety and precautions found on pages T10 & T11 of NIC's Electrolytic Capacitor catalog.
Also found at www.niccomp.com/precautions
If in doubt or uncertainty, please review your specific application - process details with NIC's technical support personnel: tpmg@niccomp.com



STANDARD PRODUCT, SPECIFICATIONS AND CASE SIZES D ϕ x L (mm)

Part Number	Cap. (μ F)	W.V. (Vdc)	Dissipation Factor +20°C/120Hz	Ripple Current Rating (mA) +85°C/120Hz	Max. ESR (Ω) +20°C/120Hz	Load Life Hours @ +85°C
NRE-LS102M6.3V10x9F	1,000	6.3	0.28	500	0.46	2,000
NRE-LS332M6.3V16x16F	3,300		0.32	1200	0.16	2,000
NRE-LS472M6.3V16x16F	4,700		0.34	1400	0.12	2,000
NRE-LS103M6.3V18x21F	10,000	10	0.38	2000	0.06	2,000
NRE-LS332M10V16x16F	3,300		0.28	1250	0.14	2,000
NRE-LS682M10V18x21F	6,800	16	0.32	1850	0.08	2,000
NRE-LS471M16V10x9F	470		0.20	400	0.70	2,000
NRE-LS222M16V16x16F	2,200		0.22	1100	0.17	2,000
NRE-LS472M16V18x21F	4,700	25	0.26	1700	0.09	2,000
NRE-LS331M25V10x9F	330		0.16	350	0.80	2,000
NRE-LS222M25V16x16F	2,200		0.18	1250	0.13	2,000
NRE-LS332M25V18x21F	3,300	35	0.20	1700	0.10	2,000
NRE-LS221M35V10x9F	220		0.14	300	1.06	2,000
NRE-LS102M35V16x16F	1,000		0.14	1000	0.23	2,000
NRE-LS222M35V18x21F	2,200	50	0.16	1500	0.12	2,000
NRE-LS471M50V16x16F	470		0.12	700	0.42	2,000
NRE-LS102M50V16x21F	1,000		0.12	1000	0.20	2,000
NRE-LS222M50V18x25F	2,200		0.14	1600	0.11	2,000

PART NUMBER SYSTEM

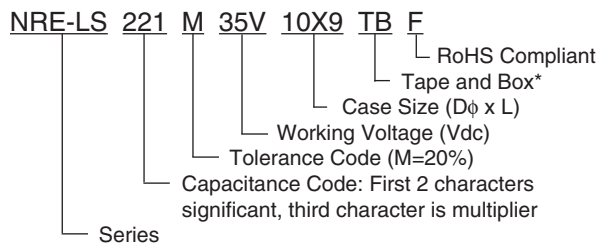

*see taping specifications for details

Miniature Aluminum Electrolytic Capacitors Taping Specifications

STANDARD RADIAL TAPING (5mm LEAD SPACING, FORMED LEADS) TR, TB

Taping Dimensions (mm)

Case Dia. (D ϕ)	4	5	6.3	8
Case Size	4x5	5x5	6.3x5	8x11.5
Dim.	4x7	5x7	6.3x7	6.3x11
d ϕ \pm 0.05	0.45	0.45	0.5	0.5
H \pm 0.75	17.5	17.5	18.5	18.5
F +0.8 ~ -0.2	5.0 -0.2 ~ +0.8			
P	12.7 \pm 1.0			
P ₀	12.7 \pm 0.2			
P ₁	3.85 \pm 0.5 (at end of tape)			
P ₂	6.35 \pm 1.0			
W	18.0 \pm 0.5			
W ₀	11.5 min.			
W ₁	9.0 \pm 0.5			
W ₂	0 ~ 2.5			
H ₀	16.0 \pm 0.5			
l	1.0 max.			
D ₀ ϕ	4.0 \pm 0.2			
Δ h	0 \pm 1.0 (at top of can)			
t	0.7 \pm 0.2 (not including lead)			

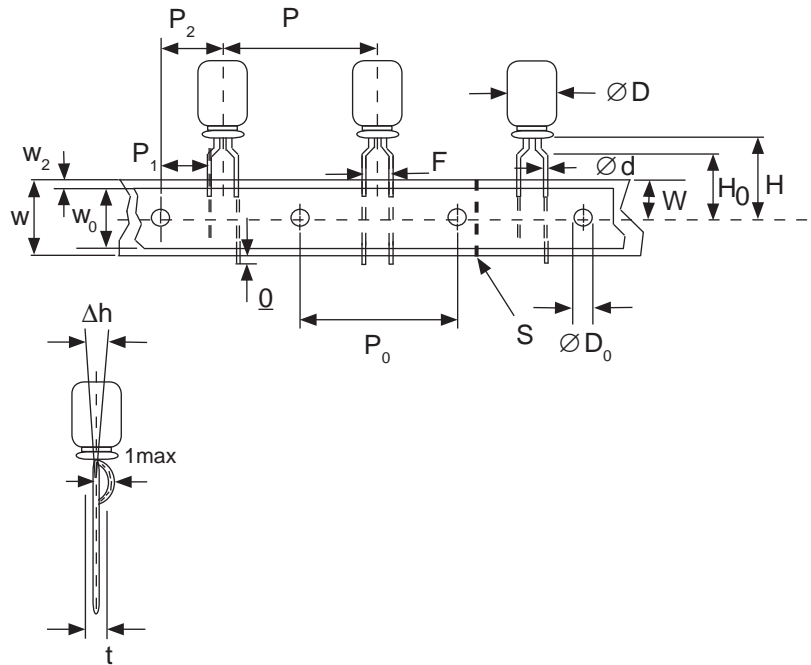

STANDARD RADIAL TAPING (5mm LEAD SPACING, STRAIGHT LEADS) TR, TB

Taping Dimensions (mm)

Case Dia. (D ϕ)	10	12.5
Case Size	All	All
Dim.	All	All
d ϕ \pm 0.05	0.6	0.6
H \pm 0.75	19.0	19.0
F +0.8 ~ -0.2	5.0	5.0
P \pm 1.0	25.4*	
P ₀	12.7 \pm 0.2	
P ₁	3.85	
P ₂	6.35 \pm 1.0	
W	18.0 \pm 0.5	
W ₀	11.5 min	
W ₁	9.0 \pm 0.5	
W ₂	0 ~ 2.5	
H ₀	16.0 \pm 0.5	
l	1.0 max.	
D ₀ ϕ	4.0 \pm 0.2	
Δ h	0 \pm 1.0 (at top of can)	
t	0.7 \pm 0.2 (not including lead)	

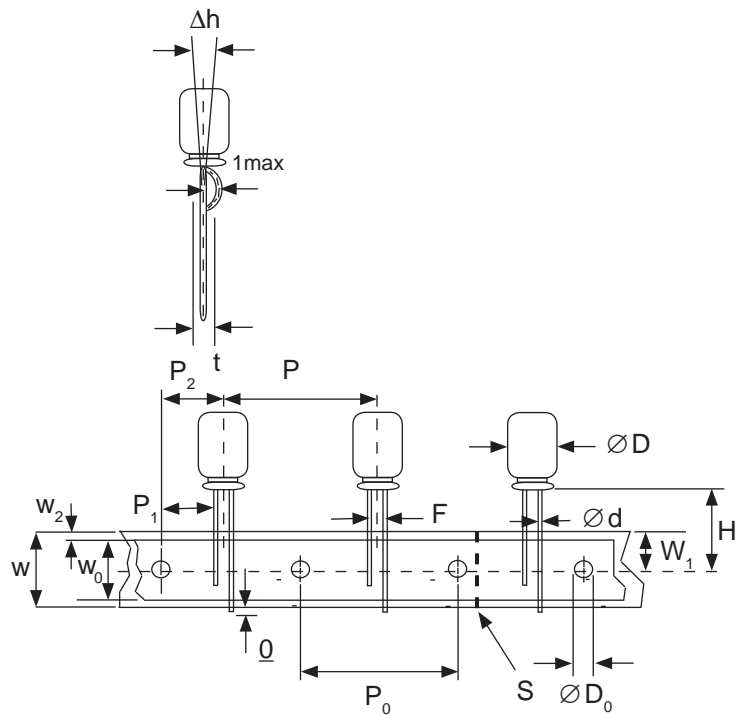

*Optional Taping Specifications

10mm diameter available with P dim. = 12.7mm
(P/N Suffix: TB12.7MMP)

12.5mm diameter available with P dim. = 15mm, P₁ = 5.0mm,
P₀ = 15.0mm & P₂ = 7.5mm (P/N Suffix: TB15MMP)

NOTE: ANODE (+) LEAD FEEDS OFF FIRST.
FOR OPTION OF NEGATIVE (-) LEAD FIRST,
SPECIFY "TRN" OR "TBN".



Miniature Aluminum Electrolytic Capacitors Taping Specifications

SPECIAL RADIAL TAPING (2.5mm LEAD SPACING, FORMED LEADS) TRF1, TBF1

Taping Dimensions (mm)

Case Dia. (D ϕ)	4		5	
Case Size Dim.	4x5 4x7	5x5 5x7	5x11	
d ϕ \pm 0.05	0.45	0.45	0.5	
H \pm 0.75	17.5	17.5	18.5	
H ₀ \pm 0.5	16.0	-	-	
F	2.5 -0.2 ~ +0.8			
P	12.7 \pm 1.0			
P ₀	12.7 \pm 0.2			
P ₁	5.1 \pm 0.5			
P ₂	6.35 \pm 1.0			
W	18.0 \pm 0.5			
W ₀	11.5 min.			
W ₁	9.0 \pm 0.5			
W ₂	0 ~ 1.5			
l	1.0 max.			
D ₀ ϕ	4.0 \pm 0.2			
Δ h	0 \pm 1.0			
t	0.7 \pm 0.2			

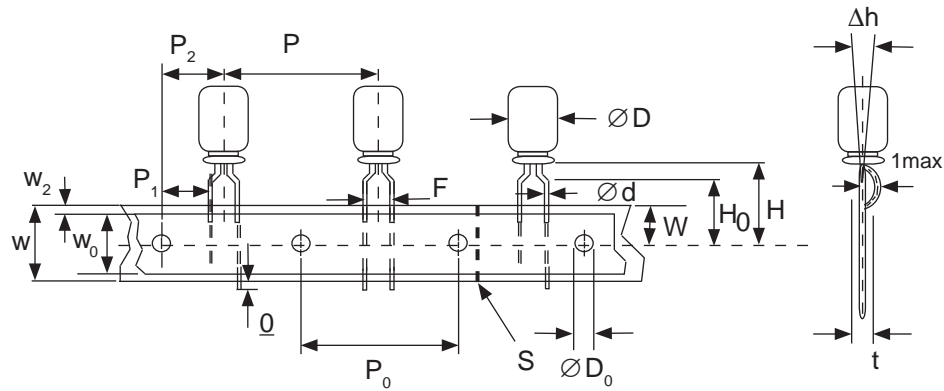

SPECIAL STRAIGHT LEAD TAPING TRST, TBST

Taping Dimensions (mm)

Case Dia. (D ϕ)	4			5			6.3		8	
Case Size Dim.	4x5 4x7	5x5 5x7	5x11		6.3x5 6.3x7	6.3x11		8x11.5		
d ϕ \pm 0.05	0.45	0.45	0.5		0.45	0.5		0.6		
H \pm 0.75	17.5	17.5	18.5		17.5	18.5		20.0		
F +0.8 ~ -0.2	2.0*	2.0	2.0		2.5	2.5		3.5		
P \pm 1.0	12.7 \pm 0.2									
P ₀	12.7 \pm 0.2									
P ₁	5.1	5.1	5.1	5.1	5.1	5.1	4.6			
P ₂	6.35 \pm 1.0									
W	18.0 \pm 0.5									
W ₀	11.5 min.									
W ₁	9.0 \pm 0.5									
W ₂	0 ~ 2.5									
H ₀	16.0 \pm 0.5									
l	1.0 max.									
D ₀ ϕ	4.0 \pm 0.2									
Δ h	0 \pm 1.0 (at top of can)									
t	0.7 \pm 0.2 (not including lead)									

* Parts with 4mm diameter are taped with a slight flare in the lead and a 2.0mm lead-space.

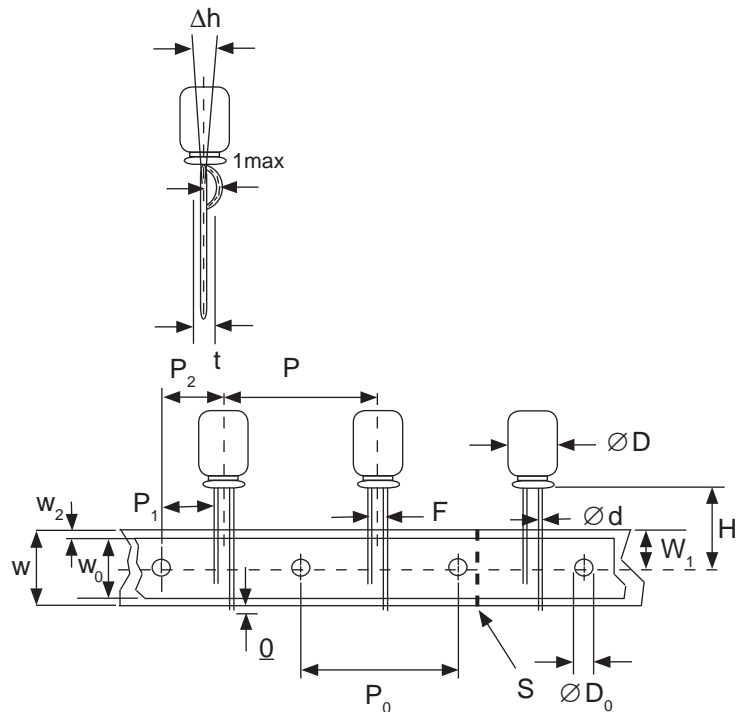

Miniature Aluminum Electrolytic Capacitors Taping Specifications

RADIAL TAPED PACKAGING

Ammo Box (Tape & Box) TB, TBF, TBST

Size of box and component quantity

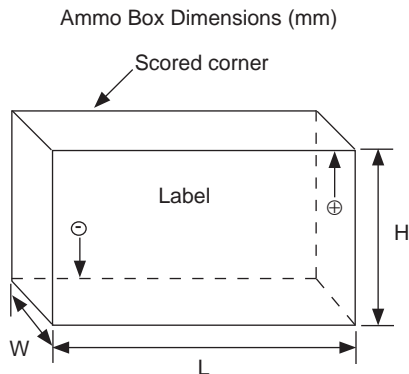

Case Dia (D ϕ) or Case Size	Q'ty per Box (pcs)	Dim. L	Dim. H	Dim. W
4x5, 4x7	2,000	331	175	43
5x5, 5x7	2,000	331	220	43
5x11	2,000	340	255	55
6.3x5, 6.3x7	2,000	331	280	43
6.3x11	2,000	331	280	48
8x11.5, 8x12.5	1,000	335	235	53
10x12.5*	500	335	190	53
10x16*	500	335	300	53
10x20*	500	335	300	55
12.x20*	500	335	300	55
12.5x25*	500	335	300	61

*Special Taping Consult Factory For Availability

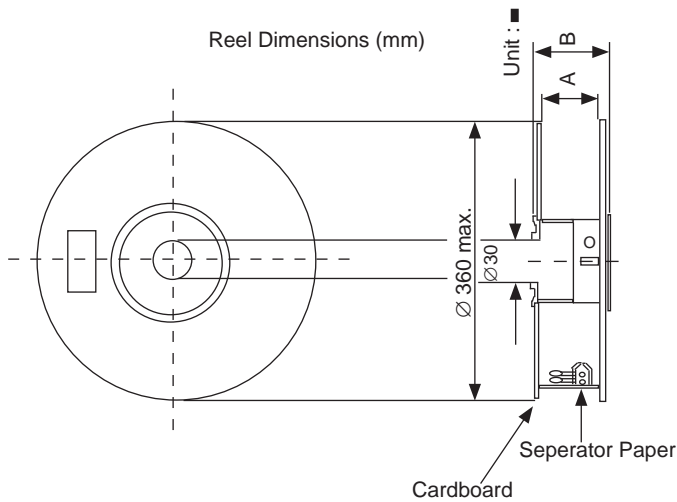

Reel Packages (Tape & Reel) TR, TRF1, TRST

Size of reel and component quantity

Case Dia (D ϕ) or Case Size	Q'ty per Box (pcs)	Dim. A	Dim. B
4 ϕ	1,800	42	52
5 ϕ	1,500	42	52
6.3 ϕ	1,000	42	52
8 ϕ	800	42	52
10x12.5*	600	42	52
10x16*	600	48	56
10x20*	600	52	60
12.x20*	250	52	60
12.5x25*	250	56	64

*Special Taping Consult Factory For Availability

